

Medworth Energy from Waste Combined Heat and Power Facility



PINS ref. EN010110
Document Reference Vol 6.4
Revision: 65.0
Deadline: 65
July^{ne} 2023

Environmental Statement Chapter 6 Traffic and Transport Appendix 6A Outline CTMP

**We inspire
with energy.**



Executive Summary

The Applicant is committed to reducing the impact of traffic during the construction of the Proposed Development. It has therefore prepared an Outline Construction Transport Management Plan (CTMP) which sets out the means by which the effects arising from construction traffic will be mitigated and managed. This Outline CTMP will be secured via a DCO requirement which will also require the submission of a final CTMP by the Applicant prior to the commencement of development. This final CTMP will need to be approved by the relevant local authority.

This Outline CTMP describes the Proposed Development including the construction accesses to the various project components. It describes the routes which it will require HGV and LVs to take when accessing the construction areas such that they avoid sensitive highways wherever possible.

There are two locations where the Proposed Development would cross an existing highway, Weasenham Lane (during the construction of the pipe bridge for the CHP Connection) and the A47 (during the construction of the Water Connections). In the case of the latter, a temporary and partial road closure would only be required should the open cut option be selected. In each case, this document sets out the proposed diversionary routes which would be first agreed with the relevant highway authority.

Potential mitigation strategies are identified to reduce the effect arising from construction traffic. These include the use of signage to direct vehicles to the construction working areas, the recording of HGVs entering the site and a commitment to low emission vehicles (EURO standard V class or better). Other measures include for the provision of a banks person, the cleaning of vehicles and condition surveys of the local highways.

Certain component parts will require delivery as abnormal indivisible loads (AILs). The Applicant has assessed a potential route from the port of Lowestoft although the actual port(s) used will be identified and presented within the final CTMP. A suggested route from the port of Lowestoft is provided.



Contents

Executive Summary	1
1. Introduction	7
1.1 Background	7
1.2 The Applicant and the project team	7
1.3 Overview	8
1.4 Purpose of the Outline Construction Traffic Management Plan	8
1.5 Structure of the Construction Traffic Management Plan	9
2. The Proposed Development	11
2.1 Introduction	11
2.2 The Proposed Development	11
2.3 Outline CTMP Study Area	12
3. Proposed Access Strategy	13
3.1 Overview	13
3.2 Location of Proposed Temporary Construction Accesses	13
3.3 Construction Access – EfW CHP Facility	13
3.4 Construction Access – Grid Connection	14
Substation Station Access	15
Temporary Construction Storage Access	15
Access for Works in the Highway	15
3.5 Construction Access – CHP Connection	15
3.6 Vehicle classification	17
3.7 Abnormal Indivisible Loads	18
4. HGV Access Strategy	19
4.1 Introduction	19
4.2 Access Strategy	19
4.3 Strategic Access	19
4.4 Local Access Strategy	20
4.5 HGV Access Strategy issues/constraints	20
4.6 EfW CHP Facility HGV Construction Access Strategy	22
4.7 Grid Connection HGV Construction Access Strategy	22
4.8 CHP Connection Local Access Routes	23
4.9 Route restrictions	23



5.	Light Vehicle Access Strategy	25
5.1	Introduction	25
5.2	LV Staff Traffic – Direct to Work Sites, including TCC	25
5.3	LV Staff Traffic – Direct to the TCC	25
5.4	LV Construction Traffic	26
5.5	Light Vehicle Construction Access Arrangements and Strategy	26
	Staff Distribution	26
	Compound to Work Site LV Strategy	27
6.	Crossing Schedule and Works in the Highway	28
6.1	Introduction	28
6.2	Crossing schedule	28
	CHP Highways Crossings	28
	Water Connections Crossing	28
	Cable Within the Highway	29
6.3	Other works affecting the local highway	29
7.	Potential Mitigation Strategies	31
7.1	Introduction	31
7.2	Site Specific Mitigation	31
	Potential Road Closures and Diversions (Motorised and Non-Motorised users)	31
	Temporary diversion signage	32
	Communications	32
	Speed limit reduction	33
7.3	Other Locations Requiring Traffic Management	33
7.4	General Construction Traffic Management/Mitigation	33
	Traffic Signage Overview	33
	Access route and point signing	34
	Other signage	34
	Core working hours	34
	Vehicle Parking Prohibition	35
	HGV construction vehicle records	35
	HGV emissions	35
	Banks person or presence of qualified personnel at access	35
	Timing of HGV movements	36
	Exceptional circumstances	36
	Cleaning of vehicles	36
	Highway condition surveys	37
	Delivery Management Systems (DMS)	37
	Information packs and communication	38
	Advanced notifications	38
	Management and Mitigation Measures requested by Royal Mail and EEAST	39
8.	Management of CTMP and Enforcements	41
8.1	Introduction	41
8.2	Monitoring and review	41
	Monitoring strategy	41
	Review	41
	Compliance	41
	Enforcement and corrective measures	42
9.	Abnormal Indivisible Load Assessment	43



9.2	Overview - Physical Restrictions Affecting a Road Movement.	43
9.3	Proposed AIL Access Route	44
10.	Access Improvements	50
Figures		51
1.	Introduction	5
1.1	Background	5
1.2	The Applicant and the project team	5
1.3	Overview	6
1.4	Purpose of the Outline Construction Traffic Management Plan	6
1.5	Structure of the Construction Traffic Management Plan	7
2.	The Proposed Development	9
2.1	Introduction	9
2.2	The Proposed Development	9
2.3	Outline CTMP Study Area	10
3.	Proposed Access Strategy	11
3.1	Overview	11
3.2	Location of Proposed Temporary Construction Accesses	11
3.3	Construction Access – EfW CHP Facility	11
3.4	Construction Access – Grid Connection	12
	Substation Station Access	13
	Temporary Construction Storage Access	13
	Access for Works in the Highway	13
3.5	Construction Access – CHP Connection	13
3.6	Vehicle classification	15
3.7	Abnormal Indivisible Loads	16
4.	HGV Access Strategy	17
4.1	Introduction	17
4.2	Access Strategy	17
4.3	Strategic Access	17
4.4	Local Access Strategy	18
4.5	HGV Access Strategy issues/constraints	18
4.6	EfW CHP Facility HGV Construction Access Strategy	20
4.7	Grid Connection HGV Construction Access Strategy	20
4.8	CHP Connection Local Access Routes	21



4.9	Route restrictions	21
5.	Light Vehicle Access Strategy	23
5.1	Introduction	23
5.2	LV Staff Traffic – Direct to Work Sites, including TCC	23
5.3	LV Staff Traffic – Direct to the TCC	23
5.4	LV Construction Traffic	24
5.5	Light Vehicle Construction Access Arrangements and Strategy	24
	Staff Distribution	24
	Compound to Work Site LV Strategy	25
6.	Crossing Schedule and Works in the Highway	26
6.1	Introduction	26
6.2	Crossing schedule	26
	CHP Highways Crossings	26
	Water Connections Crossing	26
	Cable Within the Highway	27
6.3	Other works affecting the local highway	27
7.	Potential Mitigation Strategies	29
7.1	Introduction	29
7.2	Site Specific Mitigation	29
	Potential Road Closures and Diversions (Motorised and Non-Motorised users)	29
	Temporary diversion signage	30
	Communications	30
	Speed limit reduction	34
7.3	Other Locations Requiring Traffic Management	31
7.4	General Construction Traffic Management/Mitigation	31
	Traffic Signage Overview	34
	Access route and point signing	32
	Other signage	32
	Core working hours	32
	HGV construction vehicle records	33
	HGV emissions	33
	Banksperson or presence of qualified personnel at access	33
	Timing of HGV movements	33
	Exceptional circumstances	34
	Cleaning of vehicles	34
	Highway condition surveys	34
	Delivery Management Systems (DMS)	35
	Information packs and communication	36
	Advanced notifications	36
	Management and Mitigation Measures requested by Royal Mail and EEAST	37
8.	Management of CTMP and Enforcements	38
8.1	Introduction	38
8.2	Monitoring and review	38
	Monitoring strategy	38
	Review	38
	Compliance	38
	Enforcement and corrective measures	39



9.	Abnormal Indivisible Load Assessment	40
9.2	Overview – Physical Restrictions Affecting a Road Movement.	40
9.3	Proposed AIL Access Route	41
10.	Access Improvements	47
	Figures	48

Table 6A.1 Construction Access – Grid Connection	14
Table 6A.2 Construction Access – CHP Connection	16
Table 6A.3 Vehicle Classifications	17
Table 6A.4 Issues and Constraints Management	21
Table 6A.5 HGV Accesses and Access Routes	23
Table 6A.6 Staff Distribution from Algores Way	26
Table 6A.7 Route from Lowestoft Port to Medworth EfW CHP Facility Site	44
Table 6A.1 Construction Access – Grid Connection	12
Table 6A.2 Construction Access – CHP Connection	14
Table 6A.3 Vehicle Classifications	15
Table 6A.4 Issues and Constraints Management	19
Table 6A.5 HGV Accesses and Access Routes	24
Table 6A.6 Staff Distribution from Algores Way	24
Table 6A.7 Route from Lowestoft Port to Medworth EfW CHP Facility Site	44

Figure 2.1 – Proposed Construction Compound	
Figure 2.2 – Order Limits	
Figure 3.1 – Proposed EfW CHP Facility Construction Accesses	
Figure 3.2 – Underground Cable Construction Accesses	
Figure 3.3 – CHP Connection Construction Accesses	
Graphic 3.4 – Access to CHP Corridor from Weasenham Lane (South)	14
Graphic 3.5 – Access to CHP Corridor from Weasenham Lane (North)	15
Figure 4.1 – Grid Connection Access Strategy	
Figure 4.2 – CHP Connection Access Strategy	
Figure 4.3 – EfW CHP Facility and TCC construction traffic routes and restrictions	
Figure 5.1 – Staff Distribution Points	
Figure 6.1 – Water Connections Layout	
Figure 7.1 – Typical Traffic Management	
Figure 9.1 – Route from Lowestoft Port to Medworth EfW CHP Facility Site	
Figure 9.2i-ii, – AIL SPA – New Bridge Lane/Cromwell Road	
Figure 10.1i-xi – Access Improvements New Bridge Lane	
Figure 10.2 – Access Improvements Algores Way	
Figure 10.3i-ii – Proposed Construction Access Weasenham Lane	



1. Introduction

1.1 Background

- 1.1.1 Medworth CHP Limited (the Applicant) is applying to the Secretary of State for a Development Consent Order (DCO) to construct operate and maintain an Energy from Waste (EfW) Combined Heat and Power (CHP) Facility on the industrial estate, Algores Way, Wisbech, Cambridgeshire. Together with associated Grid Connection, CHP Connection, Water Connections, and Temporary Construction Compound (TCC), these works are the Proposed Development.
- 1.1.2 The Proposed Development would recover useful energy in the form of electricity and steam from over half a million tonnes of non-recyclable (residual), non-hazardous municipal, commercial and industrial waste each year. The Proposed Development has a generating capacity of over 50 megawatts and the electricity would be exported to the grid. The Proposed Development would also have the capability to export steam and electricity to users on the surrounding industrial estate.
- 1.1.3 The Proposed Development is a Nationally Significant Infrastructure Project (NSIP) under Part 3 Section 14 of the Planning Act 2008 (2008 Act) by virtue of the fact that the generating station is located in England and has a generating capacity of over 50 megawatts (section 15(2) of the 2008 Act). It, therefore, requires an application for a DCO to be submitted to the Planning Inspectorate (PINS) under the 2008 Act. PINS will examine the application for the Proposed Development and make a recommendation to the Secretary of State (SoS) for Business, Energy and Industrial Strategy (BEIS) to grant or refuse consent. On receipt of the report and recommendation from PINS, the SoS will then make the final decision on whether to grant the Medworth EfW CHP Facility DCO.

1.2 The Applicant and the project team

- 1.2.1 The Applicant is a wholly owned subsidiary of MVV Environment Limited (MVV). MVV is part of the MVV Energie AG group of companies. MVV Energie AG is one of Germany's leading energy companies, employing approx. 6,500 people with assets of around €5 billion and annual sales of around €4.1 billion. The Proposed Development represents an investment of approximately £450m.
- 1.2.2 The company has over 50-years' experience in constructing, operating, and maintaining EfW CHP facilities in Germany and the UK. MVV Energie's portfolio includes a 700,000 tonnes per annum residual EfW CHP facility in Mannheim, Germany.
- 1.2.3 MVV Energie has a growth strategy to be carbon neutral by 2040 and thereafter carbon negative, i.e., climate positive. Specifically, MVV Energie intends to:
- reduce its direct carbon dioxide (CO₂) emissions by over 80% by 2030 compared to 2018;
 - reduce its indirect CO₂ emissions by 82% compared to 2018;



- be climate neutral by 2040; and
- be climate positive from 2040.

1.2.4 MVV's UK business retains the overall group ethos of 'belonging' to the communities it serves whilst benefitting from over 50 years' experience gained by its German sister companies.

1.2.5 MVV's largest project in the UK is the Devonport EfW CHP Facility in Plymouth. Since 2015, this modern and efficient facility has been using around 265,000 tonnes of municipal, commercial and industrial residual waste per year to generate electricity and heat, notably for Her Majesty's Naval Base Devonport in Plymouth, and exporting electricity to the grid.

1.2.6 In Dundee, MVV has taken over the existing Baldovie EfW Facility and has developed a new, modern facility alongside the existing facility. Operating from 2021, it uses up to 220,000 tonnes of municipal, commercial and industrial waste each year as fuel for the generation of usable energy.

1.2.7 Biomass is another key focus of MVV's activities in the UK market. The biomass power plant at Ridham Dock, Kent, uses up to 195,000 tonnes of waste and non-recyclable wood per year to generate green electricity and is capable of exporting heat.

1.2.8 To prepare the ES for the Proposed Development, the Applicant has engaged Wood Group UK Limited (Wood). Wood is registered with the Institute of Environmental Management and Assessment (IEMA)'s Environmental Impact Assessment (EIA) Quality Mark scheme. The scheme allows organisations that lead the co-ordination of EIAs in the UK to make a commitment to excellence in their EIA activities and have this commitment independently reviewed.

1.3 Overview

1.3.1 To suitably address potential impacts associated with the construction phase of the Proposed Development, the Applicant proposes to implement a series of embedded mitigation measures, including the preparation of an Outline Construction Traffic Management Plan (CTMP). This document presents the Outline CTMP and accompanies the Traffic and Transport Environmental Assessment prepared for the DCO Submission. A DCO requirement will secure the final details of the CTMP.

1.3.2 A description of the Proposed Development with relevance to this Outline CTMP is presented in **Section 2.1** below.

1.4 Purpose of the Outline Construction Traffic Management Plan

1.4.1 This Outline CTMP is a document that will evolve throughout the DCO application process, during the examination and following and DCO approval. It will be updated to take into account feedback received and revised in conjunction with the appointed contractor(s) at which point a Final CTMP will be prepared and submitted to the relevant highway authorities for approval prior to the point at which the first construction work commences on site.



1.4.2 Subsequent to the commencement of construction, the Final CTMP will be reviewed and where necessary updated following the first three months of construction. Thereafter it will be updated as required and as agreed with between the Applicant and the relevant highway authorities.

1.4.3 Details of consultation with Cambridgeshire County Council (CCC), Norfolk County Council (NCC) and National Highways (NH) regarding this Outline CTMP are included in **Appendix 6D (Stakeholder Engagement and Consultation Comments on the Traffic and Transport Assessments (Volume 6.4))** to **ES Chapter 6 Traffic and Transport (Volume 6.2)**. This document takes into account consultation feedback to develop a management and mitigation strategy for construction traffic on the local and strategic highways network.

1.4.4 This Outline CTMP details the proposed mitigation measures to manage traffic generated during the construction phase of the Proposed Development and minimise the likely effects on existing road users and the local community. The primary objectives of the document are as follows:

- ensuring the movement of people and materials in a safe, efficient, timely, and sustainable manner;
- keep construction traffic to a minimum during peak network periods to reduce the impact on the highway network;
- ensure that effects and disruption on local communities is minimised;
- minimise vehicle trips where possible; and
- limit the impacts on the natural and built environment.

1.4.5 This Outline CTMP reflects the assessment conclusions made in **Chapter 6: Traffic and Transport (Volume 6.2)** of the ES. This document should also be read in conjunction with the description of the Proposed Development provided in the **Chapter 3 Description of the Proposed Development (Volume 6.2)** of the ES. Terms and Abbreviations are listed in **Appendix 1F Terms and Abbreviations (Volume 6.4)**.

1.5 Structure of the Construction Traffic Management Plan

1.5.1 The remainder of this Outline CTMP is set out as follows:

- **Section 2: The Proposed Development** – sets out a summary description of the Proposed Development, its components and the vehicles that will be used during its construction, this is to inform the CTMP;
- **Section 3: Proposed Access Strategy** – sets out the Access Strategy proposed during the construction phase;
- **Section 4: HGV Access Strategy** – sets out the construction HGV Access Strategy;
- **Section 5: LV Access Strategy** – sets out the LV Access Strategy;
- **Section 6: Crossing Schedule** – sets out other construction impacts;



- **Section 7: Potential Mitigation Strategies** - sets out the potential mitigation strategies;
- **Section 8: Management of the CTMP and enforcement** – sets out the proposed management structure for the CTMP;
- **Section 9: Abnormal Indivisible Load Assessment** explains the process for dealing with abnormal loads; and
- **Section 10: Access Improvement** explains the process whereby detailed designs will be prepared and submitted to the relevant highway authorities ahead of constructing the operational accesses.



2. The Proposed Development

2.1 Introduction

2.1.1 For the purposes of this Outline CTMP, the Proposed Development is grouped into:

- EfW CHP Facility, incorporating the CHP Connection, TCC, New Bridge Lane Access Improvements and Water Connections; and
- Grid Connection via underground cable to a new Walsoken Substation.

2.1.2 The Location of the TCC adjacent to the EfW CHP Facility Site is set out in **Figure 2.1: Proposed Temporary Construction Compound** to this Outline CTMP.

2.2 The Proposed Development

2.2.1 A summary description of each Proposed Development element is provided below. A more detailed description is provided in **ES Chapter 3: Description of the Proposed Development (Volume 6.2)** of the ES. A list of terms and abbreviations can be found in **Chapter 1 Introduction, Appendix 1F Terms and Abbreviations (Volume 6.4)**.

- **EfW CHP Facility Site:** A site of approximately 5.3ha located south-west of Wisbech, located within the administrative areas of Fenland District Council and Cambridgeshire County Council. The main buildings of the EfW CHP Facility would be located in the area to the north of the Hundred of Wisbech Internal Drainage Board (HWIDB) drain bisecting the site and would house many development elements including the tipping hall, waste bunkers, boiler house, turbine hall, air cooled condenser, air pollution control building, chimneys and administration building. The gatehouse, weighbridges, 132kV switching compound and laydown maintenance area would be located in the southern section of the EfW CHP Facility site.
- **CHP Connection:** The EfW CHP Facility would be designed to allow the export of steam and electricity from the facility to surrounding business users via dedicated pipelines and private wire cables located along the disused March to Wisbech railway. The pipeline and cables would be located on a raised, steel structure.
- **TCC:** Located adjacent to the EfW CHP Facility Site, the compound would be used to support the construction of the Proposed Development. The compound would be in place for the duration of construction.
- **Access Improvements:** includes access improvements on New Bridge Lane (road widening and site access) and Algores Way (relocation of site access 20m to the south).
- **Water Connections:** A new water main connecting the EfW CHP Facility into the local network will run underground from the EfW CHP Facility Site along New Bridge Lane before crossing underneath the A47 (open cut trenching or horizontal directional drilling (HDD)) to join an existing Anglian Water main. An



additional foul sewer connection is required to an existing pumping station operated by Anglian Water located to the north-east of the Algores Way site entrance and into the EfW CHP Facility Site.

- Grid Connection: This comprises a 132kV electrical connection using underground cables. The Grid Connection route begins at the 132kV switching compound in the EfW CHP Facility Site and runs underneath New Bridge Lane, before heading north within the verge of the A47 to the Walsoken Substation on Broadend Road. From this point the cable would be connected underground to the Walsoken DNO Substation.

2.2.2 It is anticipated that the construction of the Proposed Development will take place over a 3-year period with the operational lifetime assumed to be a minimum of 40years. The decommissioning process is anticipated to last for 1-year.

2.3 Outline CTMP Study Area

2.3.1 The Study Area in the Outline CTMP covers that presented in **Chapter 6: Traffic and Transport (Volume 6.2)**.

2.3.2 The spatial scope of the Outline CTMP is based on the most probable and preferred routes for construction traffic generated by the Proposed Development. The construction traffic generated covers the movement of deliveries, equipment and of construction staff. Identification of appropriate construction routes takes into consideration the following:

- restrictions such as weight and height limits;
- suitability of routes based on a review of road types and widths;
- Consultation feedback;
- Access to the A47; and
- Impacts on the local community.

2.3.3 The Study Area includes for roads operated and maintained by CCC, NCC and NH as local and strategic road authorities.



3. Proposed Access Strategy

3.1 Overview

3.1.1 During the construction phase of the Proposed Development, temporary construction access will be required onto and from the public highway network. The only locations requiring permanent access will be the EfW CHP Facility Site (details of which are provided within **Chapter 6: Traffic and Transport (Volume 6.2)**) and the substation at Walsoken, although this access is already established.

3.2 Location of Proposed Temporary Construction Accesses

3.2.1 During the construction phase, temporary construction access is required across all elements of the Proposed Development which spans a geographical area encompassing both Cambridgeshire and Norfolk. Temporary construction access will be from a range of adopted roads as appropriate to ensure access to all locations of the Proposed Development.

3.2.2 Accesses are required for three distinct elements of the project:

- The EfW CHP Facility, including New Bridge Lane Access Improvements and Water Connections;
- The Grid Connection; and
- The CHP Connection.

3.2.3 The following section sets out in detail the access proposals identified for the construction stage for each of the three elements.

3.3 Construction Access – EfW CHP Facility

3.3.1 It is anticipated that 65% of construction vehicles (the majority of HGVs) would enter and exit the EfW CHP Facility Site via a new construction access off New Bridge Lane. A wheel wash facility would be located at the exit. This access would be via an improved at-grade road crossing over the disused March to Wisbech Railway to an access located at the same location as the permanent access to the EfW CHP Facility described in **Chapter 6 Traffic and Transport (Volume 6.2)**.

3.3.2 The design of this access would be to the same specification size and location as the permanent access that is to be provided to the EfW CHP Facility including kerbs and formal surfacing. However, during the construction phase a stone hard standing area will be required to allow for the conveyance of Abnormal Indivisible Loads as required (AILs) and in this location no kerbs are installed until after the conveyance of AILs.

3.3.3 A further access point for construction vehicles (including some HGVs) would be retained at the current site or relocated access off Algores Way to facilitate access to the northern portion of the EfW CHP Facility Site. It is anticipated that 35% of



construction vehicles would enter and exit the EfW CHP Facility Site via the Algores Way entrance. A wheelwash facility would be located at the exit.

3.3.4 It is noted that at a certain point during the construction phase a new permanent access is proposed onto Algores Way south of the existing access. When this is under construction all traffic would access the construction site via the New Bridge Lane access details of which are set out in **Chapter 6 Traffic and Transport (Volume 6.2)**.

3.3.5 **Figure 3.1: Proposed EfW CHP Facility Construction Accesses** of this Outline CTMP sets out the location of the two proposed construction accesses for the EfW CHP Facility.

3.4 Construction Access – Grid Connection

3.4.1 The Grid Connection heads east from the EfW CHP Facility Site and broadly follows the route of the A47 around the eastern periphery of Wisbech. The Grid Connection is then proposed to route along Broadend Lane to the Walsoken Substation.

3.4.2 The entire route is proposed to be constructed within the adopted highway/highway verge of New Bridge Lane, the A47 and Broadend Lane such that no direct access off the highway is required. Work in these sections will be subject to traffic management measures further details of which are set out in **Section 7.4**.

3.4.3 The accesses that would be required to allow for the construction of the Grid Connection would be at the EfW CHP Facility Site to enable the construction of the on-site electrical connection and at the site of the proposed Walsoken Substation.

3.4.4 It is also proposed to use the laybys of the A47 for some works and materials storage following consultation with NH.

3.4.5 **Figure 3.2: Underground Cable Construction Accesses** of this Outline CTMP sets out the proposed accesses to the underground cable and the locations of laybys on the A47 which are proposed to be used. [Table 6A.1 Construction Access – Grid Connection](#) sets out the accesses and their location from south to north.

Table 6A.1 Construction Access – Grid Connection

Access ID	Type of Access	Nature of Access	Grid (E,N)	Reference
EfW CHP Facility New Bridge Lane	Main Construction Access to EfW Site	Proposed New Construction (and Permanent Access) off New Bridge Lane.	545725, 307570	
Walsoken Substation	Existing Substation	Walsoken Existing Substation Access bellmouth onto Broadend Road	548219, 309215	



Substation Station Access

- 3.4.6 Access will be required to Walsoken Substation and it would be taken through the existing accesses to the Walsoken DNO Substation from Broadend Road. This access is a permanent access with appropriate visibility which requires no improvement.

Temporary Construction Storage Access

- 3.4.7 Land within the TCC and EFW CHP Facility will be required to store materials and plant as well as form a base for traffic working at the various site locations. It will be located to the south-east of the EFW CHP Facility Site. The TCC will also have car parking for the project management personnel. The construction phase layout showing the location of the TCC and laydown areas is shown in ES **Chapter 3: Description of the Proposed Development (Volume 6.2)** as **Figure 3.11 EFW CHP Facility temporary Construction Compound Layout (Volume 6.3)**.
- 3.4.8 The TCC and land within the EFW CHP Facility Site will act as a hub for the delivery of some materials. Materials may be delivered and then moved to specific areas within the EFW CHP Facility Site, or they may be delivered directly to the place they are needed such as to the Walsoken Substation.
- 3.4.9 Access to the TCC for staff will be taken from Algores Way via the proposed new access.

Access for Works in the Highway

- 3.4.10 In addition to the accesses set out in [Table 6A.1 Construction Access – Grid Connection](#) there are several locations where construction work is required in or next to the public highway (verge) in the following locations. It is proposed that access to these sites would be as follows;
- New Bridge Lane – underground cable between the EFW CHP Facility Site and A47:
 - ▶ Access to this section would be from the east via New Bridge Lane.
 - A47 – underground cable between New Bridge Lane and Broadend Road:
 - ▶ Access to this section would be directly off the A47 at appropriate managed access points in the relevant traffic management area.
 - Broadend Road – Underground Cable between A47 and Walsoken Substation:
 - ▶ Access to this section would be from Broadend Road via the A47 to the East.

3.5 Construction Access – CHP Connection

- 3.5.1 The CHP Connection runs north from the EFW CHP Facility and follows the route of the disused March to Wisbech Railway into Wisbech. Due to the urban location of the CHP Connection accesses are distributed across several urban roads in the south of Wisbech.



3.5.2 **Figure 3.3: CHP Connection Construction Accesses** sets out the proposed accesses to the CHP Connection. [Table 6A.2 Construction Access – CHP Connection](#) sets out the CHP Connection accesses and their location from south to north.

Table 6A.2 Construction Access – CHP Connection

Access ID	Nature of Access	Grid Reference (E,N)
CHP1	Access from Weasenham Lane	545762, 308635
CHP2	Access from Weasenham Lane	545762, 308635
CHP3	End of Highway – Oldfield Lane	545836, 309139

3.5.3 CHP1 and CHP2 are located adjacent to each other where the disused March to Wisbech Railway crosses Weasenham Lane. In this location there are no formal accesses to the rail corridor however the areas are open, there are no hedges, and a construction access could be provided with minimal accommodation works. It is likely some traffic management would be required in the area during the construction of the CHP connection over and either side of Weasenham Lane. **Graphic 3.4: Access to CHP Corridor from Weasenham Lane (South)** and **Graphic 3.5: Access to CHP Corridor from Weasenham Lane (North)** identify the accesses to the CHP Connection corridor from Weasenham Lane.

Graphic 3.4 Access to CHP Corridor from Weasenham Lane (South)





Graphic 3.5 Access to CHP Corridor from Weasenham Lane (North)



- 3.5.4 Accommodation works in the area would be focused on the access to the south of Weasenham Lane where currently there is a disused crossing in the way of proposed access. Further discussion with Network Rail and CCC will be required to address the status of this element of rail infrastructure and to understand how it can be moved.
- 3.5.5 Access CHP3 would be at the end of Oldfield Lane and as such no access improvements are required at this location.
- 3.5.6 In addition to the CHP1 to CHP3, construction of the CHP Connection would also be taken from the construction access for the EfW CHP Facility from New Bridge Lane described in **Section 3.3**.

3.6 Vehicle classification

- 3.6.1 A number of vehicle types will be used for the construction of the Proposed Development across all the key elements. [Table 6A.3 Vehicle Classifications](#) provides a list of the types of vehicles required to access the access points set out in this section.

Table 6A.3 Vehicle Classifications

Light Vehicles (LVs)	Heavy Good Vehicles (HGVs)
Cars	40 tonne tipper trucks
Minibus	Grab wagons



Light Vehicles (LVs)	Heavy Good Vehicles (HGVs)
4x4 Pick Up	Flat Bed HGV
Transit Type Van	Crane
Mini HIAB	AILs
Tractor	Excavator
Towed Elements (Winch/Cable Drums)	2 or 4 axel truck with HIAB
All-Terrain Vehicles (ATVs)	Concrete mixers
	Articulated HGVs

3.6.2 The list of vehicle types provided in [Table 6A.3 Vehicle Classifications](#) is not exhaustive and has been based on projects of a similar type/scale/complexity.

3.6.3 Construction machinery and on-site plant, vehicles and generator fuel tanks will be re-fuelled on site.

3.7 Abnormal Indivisible Loads

3.7.1 During the construction phase, there is a requirement for delivery of abnormal loads to the EfW CHP Facility and potentially the pipe bridge for the CHP Connection. The nature of the abnormal loads required to be delivered for these works will require delivery of Abnormal Indivisible loads (AILs).

3.7.2 Further details on AILs and access proposals are set out in **Section 9**.



4. HGV Access Strategy

4.1 Introduction

4.1.1 The Proposed Development requires construction HGVs to use site accesses within urban and rural environments. Both these environments present potential challenges for the conveyance of HGVs. Potentially, urban area HGV routes bring HGVs into high traffic areas which are used by pedestrians wishing to cross the carriageway where highways safety may be an issue. The rural environment would present routes for HGVs where roads are potentially less suitable for HGV traffic such as single tracks roads or roads with poor visibility. To address the limitations an HGV access strategy has been developed that will be utilised during the construction of the Proposed Development limiting the issues that both these environments present. This section sets out how the HGV access strategy has been developed.

4.2 Access Strategy

4.2.1 To develop the HGV access strategy two types of routes are considered as follows;

- Strategic – This is the element of the HGV access strategy that uses the Strategic Road Network (SRN) which links the wider UK highways network with the Proposed Development. For this project the strategic element of the HGV access strategy is the A47/A17 which is managed by NH.
- Local – Local elements of the HGV access strategy are A/B/C/U roads that link the SRN to each of the proposed accesses for the Grid Connection, CHP Connection and EfW CHP Facility. The local roads are managed by CCC for the EfW CHP Facility Site and CHP Connection and are managed by both CCC and NCC for the Grid Connection. Local roads range from key A roads to single track rural roads (including unsurfaced roads maintained by NCC).

4.2.2 Access to each of the construction accesses for all elements of the Proposed Development will utilise strategic elements of the highways network as far as practically possible before routing on to local elements of the highways network.

4.3 Strategic Access

4.3.1 The A47 is an element of the SRN that links the wider UK highways network to the Proposed Development.

4.3.2 The section of the A47 which is managed by NH runs between the A1 near Peterborough and Lowestoft in Norfolk. The A47 provides a connection for coastal towns in Norfolk to major settlements along the A47 corridor including Norwich, Kings Lynn and Peterborough. The A47 also provides a connection for these towns to the A1 where routes can be taken on the SRN to national destinations. The A47 has key junctions with the local road network at two locations:

- A47/B198 Cromwell Road - Access into south Wisbech; and



- A27/A1101 Elm High Road – Access into south-east Wisbech.

4.4 Local Access Strategy

4.4.1 From the SRN are a series of access routes on local roads that are required to provide HGV access to the construction accesses.

4.4.2 Access routes vary between the different component parts of the Proposed Development due to location. This section will set out the local access strategy for the EfW CHP Facility, including New Bridge Lane Access Improvements, CHP Connection, Water Connections and Grid Connection.

4.4.3 Across all elements of the Proposed Development access routes have been developed based on the following considerations:

- Height restrictions;
- Weight restrictions;
- Road classification;
- Road layout;
- Existing crossing facilities;
- Existing traffic calming measures;
- Sensitive Receptors adjacent to the public highway;
- Visibility constraints;
- Speed limits and traffic speeds;
- Areas prone to congestion;
- Significant changes in gradient; and
- Vulnerable road users (pedestrians, cyclists and equestrians).

4.4.4 In respect of the HGV access strategy, it should be noted that it has sometimes not been possible to exclude local access roads that feature some of the above constraints. Where this is the case, it has been assessed that alternative routes are considered to be worse in terms of said constraints.

4.5 HGV Access Strategy issues/constraints

4.5.1 The HGV Access Strategy encompasses the HGV routes to be used between the proposed construction accesses and the SRN. A number of common issues and constraints have been identified, with details of the mitigation proposed set out in further detail in this chapter. These are set out in [Table 6A.4 Issues and Constraints Management](#) below.



Table 6A.4 Issues and Constraints Management

No.	Issue/Constraint	Mitigation
1	Sensitive, built up areas (villages, towns) to be avoided by temporary construction traffic due to impacts on congestion, highway safety, local residents, pedestrians and air and noise pollution.	<p>The HGV access strategy and selection of access locations has removed Wisbech Town Centre from potential impacts during the construction period.</p> <p>HGVs are routed away from the Air Quality Management Area (AQMA) which is along the A1101 Elm High Road/Churchill Road corridor (other than for the construction of the UCG for limited HGVs movements).</p>
2	Avoidance, if possible, of built-up areas to avoid conflict with local residents, pedestrians, parking areas, local roads and streetscapes.	The HGV access strategy and selection of access locations has removed Wisbech Town Centre from any impacts during the construction period.
3	Avoidance of narrow rural roads.	The HGV access strategy has avoided the use of small single-track roads entirely.
4	Limited visibility at access junctions.	<p>Only one access, as set out in Section 3, will require visibility splays to be implemented. This access would be for the new EfW CHP Facility.</p> <p>The construction access has been provided with visibility splays designed to Design Manual for Roads and Bridges (DMRB).</p>
5	Impacts on pedestrian (PRoW), cyclist (National Cycle Network, sustrans and local routes) and equestrians (local routes).	<p>The project has no direct impacts on PRoW. Halfpenny Lane is represented by separate PRoWs either side of the A47. Recognising that there is a pedestrian crossing point over which the Grid Connection would cross, works to install the connection would be undertaken at night with the land reinstated.</p> <p>NCR63 is a national cycleway running along Elm Low Road and crossing the A47 south of the A47 Elm High Road junction. Excavation works to install the grid Connection would be undertaken at night with the land reinstated.</p>
6	Construction traffic impacts on capacity of junctions and links on the construction routes (SRN and local highway network).	<p>Assessment of the traffic generation on 18 highways links has been set out in Chapter 6 Traffic and Transport (Volume 6.2). The measures required to mitigate the impact of construction traffic are also included in that chapter. The Assessment indicated impacts at only 4 links during the construction phase.</p> <p>As a result of this assessment the project proposes a new tactile paving crossing linking the north and south footways on Cromwell Road (east) over New Bridge Lane.</p>



No.	Issue/Constraint	Mitigation
		A Transport Assessment (Appendix 6B, Volume 6.4) has been prepared to support the DCO application and this has indicated that based on capacity assessments of the local highways network no mitigation will be required relative to the impact of construction traffic in the week day peak hours 07:00 – 08:00 and 17:00 – 18:00.

4.6 EfW CHP Facility HGV Construction Access Strategy

4.6.1 Consultation with CCC has confirmed that access to the EfW CHP Facility Site (and to the CHP Connection, New Bridge Lane Access Improvements and Water Connections) via Elm High Road is not desirable.

4.6.2 The HGV construction access strategy from the SRN therefore is that HGVs leave the A47 at the junction with Cromwell Road and route north to the junction with New Bridge Lane. From here HGVs would route east to the proposed New Bridge Lane construction access unless they are required to access the Algores Way site entrance (for example, for site establishment works, to carry out the New Bridge Lane Access Improvements or construction works located to the north of the EfW CHP Facility Site). If the use of this secondary access is required, HGVs would continue north along Cromwell Road to the junction with Weasenham Lane and then route east to the junction with Algores Way.

4.6.3 The EfW CHP Facility HGV Construction Access locations are set out in **Figure 3.1: Proposed EfW CHP Facility Construction Accesses** to this Outline CTMP.

4.7 Grid Connection HGV Construction Access Strategy

4.7.1 Two key accesses have been identified at the northern and southern extents of the Grid Connection. To reach all access locations a local access route for HGVs is required.

4.7.2 In addition to accesses off the public highway for the Grid Connection, there will be a need for direct access from New Bridge Lane, the A47 and Broadend Road to construct elements of the project within the adopted highway land.

4.7.3 To develop the access strategy the A47 has been used as the key highway from which access into the local road network will be taken. The considerations set out above have then been applied to all potential access routes from the A47 to the Grid Connection access locations. HGV trips could be one of two types;

- HGVs delivering materials or plant directly to the construction sites; and
- HGVs delivering materials from the TCC and laydown areas within the EfW CHP Facility Site to construction sites.

4.7.4 The Grid Connection access locations, and the strategy for access are shown in **Figure 4.1: Grid Connection Access Strategy** to this Outline CTMP. [Table 6A.5](#)



Table 6A.5 HGV Accesses and Access Routes sets out the proposed routes to each of the Grid Connection accesses.

Table 6A.5 HGV Accesses and Access Routes

Temporary Construction Access	Route from SRN to Access	Comments (where applicable)
UG Cable within New Bridge Lane + EFW CHP Facility Access (TCC)	A47 – Cromwell Road – New Bridge Lane	This route avoids need for any construction traffic on the A1101 Elm High Road Corridor.
UG Cable within the A47	Direct from A47	HGV access direct from A47 into areas of traffic management while works are ongoing.
UG Cable within Broadend Road	Direct from Broadend Road	HGV access direct from Broadend Road into areas of traffic management while works are ongoing.
Walsoken Substation	A47 – Broadend Road	Access route direct from A47 to existing substation access along Broadend Road.

4.8 CHP Connection Local Access Routes

- 4.8.1 The CHP Connection is proposed to be accessed from four construction accesses, one access from New Bridge Lane via the proposed EfW CHP Facility Site access, two accesses located on Weasenham Lane (CHP1 and CHP 2) and one access at the end of Oldfield Lane (CHP3).
- 4.8.2 For CHP1 and CHP2 the same methodology as proposed for the EfW CHP Facility would be employed with HGVs leaving the A47 onto Cromwell Road and north to a junction with Weasenham Lane. HGVs would then route east to the accesses at CHP1 and CHP2 on Weasenham Lane.
- 4.8.3 For CHP3 HGVs would continue north of Cromwell Road to the junction with Oldfield Lane and then north to the end of Oldfield Lane and the construction corridor.
- 4.8.4 The CHP Connection HGV access Strategy is set out in **Figure 4.2: CHP Connection Access Strategy** to this Outline CTMP.

4.9 Route restrictions

- 4.9.1 Based upon the access strategy set out above, the Applicant will require HGVs to access the EfW CHP Facility Site and TCC either via the A47 Cromwell Road/New Bridge Lane or via the A47/Cromwell Road/Weasenham Lane/Algores Way to access the Algores Way site entrance thus avoiding the Thomas Clarkson Academy. The Applicant will impose contractual restrictions on its contractors to prevent construction HGV traffic on the following roads:



- A1101 north of A47 Elm Road roundabout;
- Churchill Road (north of Elm High Road);
- Weasenham Lane (between Algores Way and Elm High Road); and
- Access via the Freedom Bridge Roundabout.

4.9.2 **Figure 4.3: Proposed EfW CHP Facility and TCC construction traffic routes and restrictions**, illustrates the construction route restrictions.

4.9.3 The TCO(s) will be responsible for monitoring and enforcement (see **Section 8.2**).



5. Light Vehicle Access Strategy

5.1 Introduction

5.1.1 The Proposed Development will generate three types of Light Vehicle (LV) traffic across the project as follows:

- LV Staff Traffic – Direct to Construction Work Sites;
- LV Staff Traffic – Direct to the TCC; and
- LV Construction Traffic – Traffic from the TCC/EfW CHP Facility Site to proposed construction work areas along the underground cable route.

5.1.2 This section sets out how a LV construction traffic access strategy has been developed.

5.2 LV Staff Traffic – Direct to Work Sites, including TCC

5.2.1 This element of the LV traffic generation will comprise staff travelling to and from their home/overnight accommodation to construction sites as follows:

- The TCC;
- The CHP Connection; and
- The Access Improvements and Water Connections works on New Bridge Lane.

5.2.2 These trips will take place in private cars or work vans. Staff may travel directly to work sites which in the case of the EfW CHP Facility Site requires them to travel to the TCC.

5.3 LV Staff Traffic – Direct to the TCC

5.3.1 This element of the LV traffic generation will comprise staff travelling to and from their home/overnight accommodation to the TCC for the Grid Connection, accessed from Algores Way to commence work. These trips are related to:

- The Grid Connection (Underground Cable); and
- Substation Works.

5.3.2 These trips will take place in private cars or work vans. Staff will gather on site, form into teams and then leave the compound after sufficient work briefs, pick up materials and plant and start work on a local area of the project.

5.3.3



5.4 LV Construction Traffic

- 5.4.1 This element of the LV traffic generation will compromise staff leaving the TCC on either Algores Way (Staff trips) or New Bridge Lane (materials deliveries from TCC to sites). Staff would leave in teams and travel to a proposed work site for their workday and then returning to the compound at the end of the day.
- 5.4.2 These trips will take place in LVs predominantly but may also be undertaken in 4x4 vehicles and private cars. Where required these works vehicles would collect materials and plant.

5.5 Light Vehicle Construction Access Arrangements and Strategy

Staff Distribution

- 5.5.1 The distribution of staff trips directly to the compound or directly to construction sites has been based on Journey to Work data from the 2011 UK Census ¹ based on the area of E01033111 (Fenland 003H). This area includes the existing New Bridge Lane industrial area and is considered a suitable location to enable an understanding of existing staff commuter patterns to industrial type developments in Wisbech.
- 5.5.2 Due to the nature of staff travel to and from a wider range of destinations, a more comprehensive set of distribution locations on the local highways network base has been assumed and these are shown in **Figure 5.1: Staff Distribution Points** to this Outline CTMP.
- 5.5.3 [Table 6A.6 Staff Distribution from Algores Way](#) sets out the indicative percentage split base for the journey to work.

Table 6A.6 Staff Distribution from Algores Way

Staff Distribution ID	Exit Link from Study Area	Percentage
A	A47 (North)	14%
B	St Pauls Road (East)	0%
C	Lynn Road (West)	0%
D	Wilkins Road (East)	1%
E	Broadend Road (West)	1%
F	A1101 (South)	11%

¹ Office of National Statistics. 2011 Census.



Staff Distribution ID	Exit Link from Study Area	Percentage
G	Churchill Road (North)	21%
H	Cromwell Road (North)	23%
I	A141 March Road (South)	8%
J	A47 (West)	8%
K	B1101 Main Road (South)	4%
Internal	-	9%

5.5.4 Staff routing does not have the same restrictions as HGVs set out in **Section 4** and trips from home to work would be assumed to take the most appropriate route to site.

Compound to Work Site LV Strategy

5.5.5 The LV trips from compounds to the works sites per day would follow the same routing as the HVG access strategy set out in [Table 6A.5 HGV Accesses and Access Routes](#)~~Table 6A.5 HGV Accesses and Access Routes~~.



6. Crossing Schedule and Works in the Highway

6.1 Introduction

- 6.1.1 In addition to the routing of HGV and LV construction traffic, this Outline CTMP also considers the impacts of all underground cable and CHP crossings of the local and strategic highways network. It also outlines the measures proposed to ensure that works affecting the public highway are undertaken with the agreement of the local highway authority or the strategic highway authority.

6.2 Crossing schedule

- 6.2.1 The installation of underground cables as part of the Grid Connection has the potential to impact on both the SRN and LRN where the respective infrastructure passes under the highway. However, the design of the Grid Connection includes for the entire route running within the adopted highway, rather than across these roads. Further details on management of construction of underground cables within the highway is included later in this section.
- 6.2.2 The construction of the CHP Connection would also affect the LRN within Wisbech.
- 6.2.3 This section sets out the locations of the crossing points where the CHP Connection and Water Connections are being constructed and further details on management of cables proposed within the highway.

CHP Highways Crossings

- 6.2.4 The CHP Connection is proposed to cross the public highway at one location, Weasenham Lane in Wisbech.
- 6.2.5 The crossing of this route will be done by an elevated pipe bridge which will be constructed overnight to minimise the impact on the local highways network. This may require a temporary closure or active management measures when the bridge is lifted into position.

Water Connections Crossing

- 6.2.6 The potable Water Connections is proposed to cross the public highway at one location, the A47 between Cromwell Road and Elm High Road. The route of the water connection and the crossing of the A47 is shown as **Figure 6.1 Water Connection Layout** to this document.
- 6.2.7 Two options are proposed, either via HDD or open cut. Only one of these approaches will be implemented and it is only with the open cut approach that traffic management would be required. It is proposed this could be done by closing one half of the carriageway and the use of signal control. Working overnight would avoid undue impacts on the local highways network.



Cable Within the Highway

6.2.8 The proposal for the installation of the underground cable along New Bridge Lane, A47 and Broadend Lane is proposed to be undertaken using an open cut method along the entire route and this will result in the need for short road closures along New Bridge Lane and traffic management on the A47 and Broadend Road.

6.2.9 The proposed approach for installing the cable in the highway involves the following approach:

- Appropriate Traffic Management arrangements to be installed by appointed construction contractor;
- Works to be undertaken overnight (19:00 – 06:00); and
- Approximate length of excavations per night would be 200m with two to three excavation/reinstatement teams working concurrently:
 - ▶ Maximum length of road closure per night would therefore be 300m.
- Excavations from the verge/carrageway ensuring National Highways infrastructure is sufficiently protected at all times:
 - ▶ Joint bays located away from the carrageway edge as far as reasonably possible.
- All spoil (if cannot be stored on verge) to be removed from the working area and stored at the TCC compound/EfW CHP Facility Site;
- Reinstatement of road/verge to existing levels; and
- All works will be compliant with the National Highways Regulations including NRSWA.

6.2.10 The proposed construction methodology has been developed following comments from CCC and NH. This has led to the following approaches to the installation of the underground cable;

- The ducting route at Elm High Road roundabout location takes into consideration CCCs possible future works. Ducts will be installed in the grass verge/footpath and the junction will be crossed on the Elm High Road arm.
- Installation of a ducting route at and around the A47/Broadend Road will be installed approximately 2m deep to allow for the provision of a roundabout at the junction in the future.

6.3 Other works affecting the local highway

6.3.1 In addition to the placement of cables, the Proposed Development includes for the creation of new accesses to the highway. Prior to the construction of these accesses the Applicant will provide detailed drawings of the works to the relevant highway authority for its approval in accordance with Requirement 7 of Schedule 2 to the draft DCO (Volume 3.1). These details will be supplemented by information setting out an agreed timeline for inspection prior to subsequent adoption and an agreed maintenance period by the Applicant.

6A30



- 6.3.2 Detailed drawings will also be submitted for approval for any proposed accesses that do not connect directly to the public highway, for example, access from the EfW CHP Facility Site to Algores Way.
- 6.3.3 Temporary works in the highway may require temporary prohibition or restriction of use of the highway. The Applicant will first consult with the relevant highway authority providing details of the works proposed and intended duration of any prohibitions or restrictions together with any appropriate traffic management measures such as temporary signals or signage. The Applicant will comply with the relevant highway authority's reasonable requests in respect of such temporary works.



7. Potential Mitigation Strategies

7.1 Introduction

7.1.1 This section explains the types of traffic management measures that may be required across the construction phase to allow for safe and convenient working practices and access to construction sites.

7.1.2 There are a number of measures that could be implemented to mitigate the impacts of construction traffic and these are set out in the section below.

7.2 Site Specific Mitigation

Potential Road Closures and Diversions (Motorised and Non-Motorised users)

7.2.1 There will be the need for some short (potentially) overnight road closures in two locations;

- New Bridge Lane – Road Closure - for the installation of cable via open cut methodology. This road is a single lane track, however access for Non Motorised users (NMUs) will be maintained with an access corridor maintained and separated from the construction activities by site hoardings or temporary fencing:
 - ▶ New Bridge Lane – Diversion – A diversion for vehicles can be accommodated by using access to either side of the closure via New Bridge Lane from the Cromwell Road junction to the west or New Drove from the East. It should be noted New Bridge Lane is not a through route currently and traffic on this route is extremely limited.
- Weasenhams Lane – Road Closure – For the installation of the pipe bridge over the existing two lane single carriageway, however access for NMUs will be maintained if possible and subject to the agreement of the relevant highway authority:
 - ▶ Weasenhams Lane – Diversion – A diversion can be accommodated using a route from one side of the closure to the other using Weasenhams Lane – A1101 Elm High Road – A47 – Cromwell Road – Weasenhams Lane (and the reverse route).

7.2.2 The details and timings of road closures will require discussion and agreement between the appointed EPC Contractor and relevant highway authority (CCC) prior to the commencement of the works.

7.2.3 The Applicant is aware that vehicular access to 10 New Bridge Lane is via New Drove until such time that access from Cromwell Road is open. Similarly, new Bridge Lane is used by NMUs. The Applicant will aim to maintain unrestricted vehicular access to 10 New Bridge Lane and access for NMUs throughout the construction period. Any requirement to temporarily close the highway with the potential to affect unrestricted access to the property will be communicated to the tenant and owner



in advance. The timing of such notice will be set out within the Stakeholder Management Plan referenced within the **Outline CEMP** at **Section 3.5 (Volume 7.12)**.

- 7.2.4 Details of the route along New Bridge Lane to be maintained open for NMUs, including its location, design and the means by which it would be separated from construction working areas will be provided to the relevant highway authority for its agreement prior to the commencement of the construction of the Access Improvements to New Bridge Lane. These details will confirm the design of the screening to the construction areas including the materials to be used, height and elevational appearance.

Short-term temporary PROW closures

- 7.2.5 In addition to the above road closures, the construction of Grid Connection will require the short-term, temporary closure of the verge of the A47 in locations at which PROWS (along Halfpenny Lane – Wisbech 21, Elm 6, Meadowgate Lane, Green Lane) and the national cycle route NCR63 cross the A47. NMUs do cross the A47 at these points and the site specific mitigation is designed to protect their ability use these routes, safely, during construction. The Applicant and its EPC Contractor will aim to retain access at all times during construction recognising however that at each location for 1-2 evenings a temporary closure may be required to excavate and install the Grid Connection. Temporary closures of any highway, NMU facility or public right of way will be undertaken as a 'last resort' and will be agreed with the relevant highway authority consistent with paragraph 7.2.6 below.
- 7.2.6 A programme for the undertaking of all works requiring temporary closure of any highway (including any that have a direct impact on an adjoining NMU route or public right of way) that shall contain the timings for undertaking works in the locations referred to above will be first submitted to and agreed with the relevant highway authority.

Temporary diversion signage

- 7.2.7 In locations where temporary road, footpath and cycleway closures and diversions are required, temporary signage will be installed by the appointed construction contractor in accordance with Traffic Signs Regulations and General Directions (TSRGD) published by the DfT. The type and location of signage will be first agreed with the relevant highway authority.
- 7.2.8 The proposed diversion routes will be prescribed as part of the details to be approved by the relevant highway authority in accordance with the requirements of the final CTMP.

Communications

- 7.2.9 In advance of potential road and footpath closures a communications plan will be developed by the Applicant and its EPC Contractor. This will be prepared in consultation with the relevant highway authorities and local authorities in order to agree the appropriate timescale for the provision of advanced notice and the stakeholders to be communicated. The communications plan will set out the date



and times of any closures and diversions, any additional mitigation measures which the Applicant proposes and the contact details of the Community Liaison Manager.

Speed limit reduction

7.2.10 CCC as local highway authority supports the Applicant's proposal to reduce the speed limit along New Bridge Lane once the New Bridge Lane Access Improvements have been completed and the road is available to be used by construction traffic. The Applicant's DCO Article 17 gives it the ability to make traffic regulation measures and this will be updated to include a specific reference to changing the speed limit on New Bridge Lane to 30mph as suggested by CCC. Alternatively the Applicant can apply to CCC with a request to reduce the speed limit to 30mph via a Traffic Regulation Order (S84 of the Road Traffic Regulation Act 1984). It is the intention that this speed limit is made permanent.

7.3 Other Locations Requiring Traffic Management

7.3.1 Temporary traffic management will be deployed throughout the construction programme at various locations other than the highways crossings. Construction activities that may require temporary traffic management include but are not limited to:

- proposed access locations;
- sections of highway within which Underground Cable will be installed;
- around proposed TCC and switching station; and
- roads being used for the delivery of materials to the work areas.

7.3.2 The type of temporary traffic management deployed will vary and could include temporary traffic signals, manned stop/go boards, road narrowing/widening and temporary speed restrictions.

7.3.3 All temporary construction traffic management implementation plans will need to be approved by NH, CCC and/or NCC (location dependant) and will be applied in accordance with guidance and procedures as required by Section 14 of the Road Traffic Regulation Act 1984.

7.3.4 Although site specific traffic management cannot be defined at this time as this will be within the remit of the construction contractor **Figure 7.1 Typical Traffic Management** of this Outline CTMP sets out a typical example of how the temporary works in the highway will be managed.

7.4 General Construction Traffic Management/Mitigation

Traffic Signage Overview

7.4.1 Where temporary traffic management measures are required, these will be agreed in advance with the relevant highway authorities, NH for the SRN and CCC/NCC for the local highways network. Any temporary road closures/diversions will be advertised in advance and alternative routes indicated through signage. Where



required, temporary speed restrictions will be sought through Temporary Traffic Regulation Orders which would be secured through the DCO.

7.4.2 **Figure 7.1 Typical Traffic Management** of this Outline CTMP sets out the proposed arrangements for signage approaching traffic management schemes.

Access route and point signing

7.4.3 Temporary signage will be erected along construction traffic routes on the CCC/NCC network to provide directional routing information for construction vehicles, to ease navigation between the SRN and the construction sites and compounds.

7.4.4 Temporary signage warning other road users of the likely presence of construction vehicles will also be provided in the vicinity of each construction access location.

7.4.5 Where necessary warning signs at “short cuts” and “rat runs” will be erected to remind construction vehicle drivers to utilise the prescribed construction traffic routes.

7.4.6 This signage will be in accordance with Traffic Signs Regulations and General Directions (TSRGD), DfT (2016)).

Other signage

7.4.7 All signage will be provided in accordance with Traffic Signs Regulations and General Directions (TSRGD), DfT (2016) published by the DfT. Signage to be erected includes:

- Traffic warning signs for road closures;
- Traffic warning signs with contact details of the relevant contractors so the public can request information/updates; and
- Advanced warning signs of road closures.

7.4.8 Network Rail currently maintains a sign on its land, the site of the former crossing of the Disused March to Wisbech Railway and New Bridge Lane, to state that there is no public right of access across its land. The Applicant, with the agreement of Network Rail, will maintain and/or reposition/replace the sign(s) from the commencement of construction through to and including the period of operation such that NMUs are clear as to the status of their rights of access. Prior to installation, the wording and positioning of the sign will also be provided to CCC for review and comment.

Core working hours

7.4.9 Construction work will take place in accordance with set “core hours” which will be secured by a DCO Requirement.

7.4.10 A limited number of works may be required outside of the core hours and these include the construction of the Grid Connection which will be undertaken primarily at night. Further information on the types of works likely to take place outside of core



hours is provided within **Chapter 3: Description of the Proposed Development, (Volume 6.2)**.

7.4.11 Construction work would take place between 07:00 and 19:00 Mondays to Fridays and between 08:00 and 16:00 on Saturdays (the core hours), although the mobilisation and demobilisation of staff may take place for an additional hour at the start and end of each day.

7.4.12 Construction activity on Sundays, public holidays or bank holidays would not take place, other than in exceptional circumstances.

Vehicle Parking Prohibition

7.4.127.4.13 No HGVs or LVs or construction workers' cars associated with the construction of the Proposed Development will be permitted by the Applicant to park along Algores Way, Europa Way, Anglia Way, Salters Way and New Bridge Lane unless in conjunction with any construction works taking place within the highway. Access to businesses will be maintained at all times.

HGV construction vehicle records

7.4.137.4.14 All HGV construction vehicle movement associated with the Proposed Development will be recorded and timed as vehicles enter and leave all construction compounds and sites as part of a delivery management system (DMS). DMS records will be compiled and stored centrally so that any complaints received concerning driver/vehicle conduct can be first referenced against the DMS to confirm whether the vehicle in question is associated with the Proposed Development. Poor driver/vehicle conduct and management will be addressed and the means by which this will be achieved will be set out in the final CTMP.

HGV emissions

7.4.147.4.15 All road-based vehicles used in for construction will be to a EURO standard V class or better.

Banksperson or presence of qualified personnel at access

7.4.157.4.16 Qualified personnel (banksperson) will be placed at key locations where and when necessary during construction. Key locations are likely to include construction accesses at key parts of the highways network including:

- The vehicle entrance to the EfW CHP Facility Site and TCC on Algores Way;
- Once constructed, the vehicle entrance to the EfW CHP Facility Site on New Bridge; Lane; and
- The points at which the Grid Connection would cross the between the PRoWs either side of the A47 (e.g. Halfpenny Lane) and at the crossing points during busy periods.

7.4.167.4.17 Qualified personnel will also be provided at other sensitive locations where necessary.



Timing of HGV movements

[7.4.177.4.18](#) HGV movements will normally, subject to exceptions where required, take place during the core working hours as set out above and for the hour before and after these core working hours due to the distances potentially involved in reaching the construction sites.

Exceptional circumstances

[7.4.187.4.19](#) There may be exceptional circumstances when construction traffic routes on the SRN or the LRN are compromised which will impact on vehicles not being able to use these routes or do so, within the core hours defined above. Exceptional circumstances could be one or more of the following:

- for the delivery of AILs, which may cause congestion on the local road network, where the relevant highway authority has been notified prior to such works 72 hours in advance;
- where a traffic accident or other similar incident on the highway network that disrupts the normal operation of the highway network or results in a highway closure;
- where a breakdown of a LV/HGV en-route to a construction site or compound occurs and then arrives later due to time critical reasons;
- where work is requested to be completed out of hours by the local planning authority;
- where there is a need for emergency health and safety requirements (incident); and
- where there is a need to implement urgent mitigation activities such as emergency flood prevention works.

[7.4.197.4.20](#) In the event of an exceptional circumstance, the following impacts need to be considered with regards to highways and construction safety:

- Incidents on the highway network that could result in stoppage (at previously agreed locations) or rescheduling of deliveries;
- Incidents on the highway network causing delays, resulting in construction vehicles travelling outside of approved movement hours; and
- Impacts of deliveries not being made, which due to a lack of equipment or materials, could require a stop to construction works leading to delays to construction programme.

Cleaning of vehicles

[7.4.207.4.21](#) All construction vehicles exiting from a construction site will be checked and cleaned manually (or if it is deemed necessary, will pass through the wheel cleaning facility) prior to using the public highway to prevent the debris from being transferred off the site onto the road. If required, a road sweeper will be utilised to further ensure that the CCC/NCC network remains safe and clear of debris.



Highway condition surveys

[7.4.247.4.22](#) The public highway maintainable at public expense shall be the subject of highway condition surveys along:

- Cromwell Road, from its junction with the A47 up to Weasenham Lane;
- Weasenham Lane to its junction with Algores Way; and
- Algores Way and New Bridge Lane to the corresponding construction and operation site accesses

[7.4.227.4.23](#) The surveys shall also include the boundary features and surfacing along PROWs and any other adjoining highways maintainable at public expense which directly adjoin the Order limits. The distance over which these surveys are to be undertaken and the survey method are to be first agreed with the relevant highway authority.

[7.4.237.4.24](#) These highway condition surveys shall take place before construction commences, once during the construction programme and following the completion of construction, to ensure that the surface and boundary features of the highway and/or PROW remains in good repair and highway safety is maintained. The surveys will be paid for by the Applicant together with the requisite processing of data collected. The condition surveys will also enable any repairs to be made in a timely manner throughout the construction period.

[7.4.247.4.25](#) At the end of the construction period, the same highways and PROWS shall be subject to a final 'construction' condition survey and a programme of works (where appropriate to both the surface and structure) to restore them to the condition they were in before the construction period began will be agreed with the relevant local highway authority. The works will either be implemented by the Applicant or the relevant highway authority, in the case of the latter, such works would be funded by the Applicant.

[7.4.257.4.26](#) The highway condition surveys will be undertaken as a video survey (unless otherwise agreed by the relevant highway authority – for example, in the case of PROWs other methods may be more appropriate). The Applicant commits to undertaking these surveys.

[7.4.267.4.27](#) The highway condition surveys will be undertaken by an independent jointly approved highway condition survey company to remove the possibility of bias. The Applicant commits to the use of such a contractor.

[7.4.277.4.28](#) Should the relevant police or highway authority institute a diversion(s) from the construction traffic routes shown on Figure 4.3 that is likely to last for a period of more than 48 hours then Applicant shall notify the relevant highway authority. The requirement for a highway condition survey of the diversionary route shall be confirmed by the relevant highway authority. Should the highway condition survey identify damage caused as a result of traffic from the Proposed Development, the scope and programme for repair will be agreed with the relevant highway authority.

Delivery Management Systems (DMS)

[7.4.287.4.29](#) Records will be kept of all deliveries being made to construction sites. Personnel will be located at key construction site access locations. This will ensure the



management of deliveries and allow the number of vehicles accessing/egressing the sites to be recorded.

[7.4.297.4.30](#) This information will be collated by the Applicant and retained for reference.

[7.4.307.4.31](#) The objectives of the DMS are:

- To control the delivery of materials and equipment in line with the construction programme;
- To manage the number of construction vehicles on the road network where possible (will be scheduled to meet/adhere to any agreed restrictions); and
- Ensure construction vehicles do not exceed any agreed restrictions e.g., peak period travel through certain towns/villages/junctions.

Information packs and communication

[7.4.317.4.32](#) Information packs will be provided to all contractors and will form part of the contractual agreement between the contractors and the Applicant. The information pack will contain details of the following CTMP requirements:

- HGV route restrictions;
- LV traffic routes;
- Non compliance procedure;
- Complaints procedure;
- CTMP protocols for all contractors including a code of good practice; and
- CTMP contacts (emergency and non-emergency).

[7.4.327.4.33](#) Information packs and communication details will be shared with the highway authorities as necessary ahead of any construction works.

Advanced notifications

[7.4.337.4.34](#) The Applicant with the EPC Contractor will maintain vehicle and pedestrian access to businesses and properties during construction of the Proposed Development.

[7.4.347.4.35](#) The Applicant with the EPC Contractor shall issue advanced notification of temporary works affecting the highway proximate to businesses and properties on:

- New Bridge Lane Access Improvements: New Bridge Lane, Slaters Way and Cromwell Road;
- Algores Way Access Improvements: Algores Way;
- CHP Connection: Weasenham Lane;
- Grid Connection: New Bridge Lane and Broadend Road;
- Foul Water Connections: Algores Way;



- Potable Water Connections: New Bridge Lane (north and south of the A47): and
- TCC: Algores Way.

[7.4.357_4.36](#) Where necessary, the Applicant with the EPC Contractor will contact local businesses and properties to discuss and agree arrangements to ensure access is maintained during the temporary highway works.

Management and Mitigation Measures requested by Royal Mail and EEAST

[7.4.367_4.37](#) Royal Mail provided comments in its response to statutory consultation. These comments have been reviewed and have been included within the CTMP as a commitment.

[7.4.377_4.38](#) The East of England Ambulance service (EEAST) together with the Cambridgeshire and Peterborough Integrated Care System (CPICS) requested that they, together with Cambridgeshire Constabulary and Cambridgeshire Fire and Rescue Services, be provided with the opportunity for site familiarisation visits, incident logs and advanced warning of works which may have the potential to affect the free flow of traffic on the highway within their relevant representation (RR-013). The establishment of liaison meetings was also requested.

Royal Mail

[7.4.387_4.39](#) Royal Mail requested that the following wording is added to the draft CTMP:

- Royal Mail is consulted by Medworth CHP Limited or its contractors at least one month in advance on any proposed road closures/diversions/alternative access arrangements, hours of working,
- where road closures/diversions are proposed, Medworth CHP Limited or its contractors liaise with Royal Mail at least one month in advance to identify and make available alternative highway routes for operational use, where possible, and
- the final CTMP should include a mechanism for Medworth CHP Limited or its contractors to inform Royal Mail about works affecting the local highways network (with particular regard to access to and from Wisbech Delivery Office PE14 0RA).

[7.4.397_4.40](#) The Applicant accepts these comments, and it is a commitment of this CTMP that Royal Mail will be consulted as set out above.

EEAST, CPICS, and other Emergency Services.

[7.4.41](#) The Applicant with the EPC Contractor will establish a liaison group between the Applicant, EPC Contractor, CCC and FDC highway authorities, FDC and BCKLWN, the East of England Ambulance Trust (EEAST), Cambridgeshire and Peterborough Integrated Care System (CPICS), Cambridgeshire Constabulary and Cambridgeshire Fire and Rescue Services. The agenda, timings, roles and responsibilities will be agreed as part of the wider Stakeholder engagement plan which is committed to within the **CEMP (Volume 7.12)**. [The liaison group shall also be extended to include invitations to groups representing users of public rights of](#)



way, for example Fenland Ramblers and organisation representing horse riders, cycle groups, other NMUs and others such as local health groups.

7.4.407, 4.42 In addition, the Applicant will:

- Organise via the liaison group site familiarisation visits at appropriate points during the construction of the Proposed Development.
- Provide reports summarising any health and safety incidents that may occur on site during construction; and
- Provide advanced warning of any works which may have the potential to affect the free flow of traffic on the surrounding highway network.



8. Management of CTMP and Enforcements

8.1 Introduction

8.1.1 It is important that a strong management structure is in place to ensure the CTMP objectives are met, and that continued monitoring and reviewing of the CTMP is carried out.

8.1.2 A Transport Coordinator (TCO) will be appointed to implement the CTMP. As several contractors will be appointed to undertake the varying construction works, it is unknown at this stage whether one TCO will be required, or whether each contractor will appoint an individual TCO. This will be agreed as part of the CTMP process.

8.1.3 The TCO will have the following transport related responsibilities:

- Monitor contractor obligations with regards to the CTMP;
- Liaise with and report to the local highway authorities and National Highways about mitigation and remedial measures as required;
- Update the CTMP as required; and
- Resolve issues and problems through liaison with Stakeholders.

8.2 Monitoring and review

Monitoring strategy

8.2.1 The TCO(s) appointed by the contractor(s) will undertake necessary monitoring to ensure compliance with the requirements of the CTMP, including the maintenance of records and coordination of traffic management measures to include the monitoring of HGV routes and compliance with the routing restrictions set out in **Section 4.9**.

8.2.2 The contractor(s) will ensure that a suitable, trained, member of staff is employed to conduct surveys and monitor construction vehicle activity at specific locations along the construction route network to ensure adherence to the CTMP.

Review

8.2.3 The TCO(s) will monitor and review the CTMP. These reviews are required to ensure that the CTMP delivers on the commitments and achieves the agreed goals.

Compliance

8.2.4 As part of the CTMP a series of mechanisms will be established to provide all parties with a clear understanding of the enforcement procedures that will be applied if the



requirements contained within the CTMP are not achieved. It is anticipated that these mechanisms will be determined prior to construction and will include:

- The EPC Contractor(s), through the relevant TCO, will implement the CTMP, adhere to the requirements and meet the goals through management practices. This will include briefing on the obligations of the CTMP, DMS briefing, driver inductions and compliance guidance.
- Contractual requirements – to be implemented as part of the CTMP compliance methodology will be included in the EPC Contractor's contract, these will be subject to a performance review by the Applicant.
- Actions – To be taken if the commitments of the CTMP are breached.

Enforcement and corrective measures

8.2.5 The Applicant will ensure that appropriate measures are taken to monitor contractor behaviour and performance and where appropriate, ensure corrective measures are taken to resolve, redress and enhance any service performance, which is in breach of the requirements of the CTMP.

8.2.6 The Applicant will require that the appointed EPC Contractor's disciplinary procedures incorporate the commitments, included in the CTMP, and that these items are reflected in the contract between the Applicant and the relevant contractor.



9. Abnormal Indivisible Load Assessment

9.1.1 The construction of the EfW CHP Facility will require the conveyance of large equipment, plant and other elements of the facility. This is likely to include cranes, silos, boiler and chimney elements and the turbine generator. This is not an exhaustive list and will be reviewed as the project develops when the final number of AILs will be confirmed.

9.1.2 It is understood that the Grid Connection, CHP Connection, New Bridge Lane Access Improvements and Water Connections would be able to be constructed using standard HGVs, therefore it is likely that all AILs for the construction of the Proposed Development will need to route into the EfW CHP Facility construction site.

9.2 Overview - Physical Restrictions Affecting a Road Movement.

9.2.1 A maximum headroom of 5.03 metres (16'6") is maintained within the UK on major motorway and trunk road routes, but this is not guaranteed, and the actual height is posted on structures, such as bridges and gantries. The UK electricity supply industry and plant manufacturers generally work to a travelling height of 4.95 metres (16'3") to allow for a safety margin.

9.2.2 Where restrictions are caused by overhead services such as telephone lines and local power distribution lines, it is feasible to raise or underground these along relatively short routes. The services could also be temporarily disconnected, although this is not popular with the end user. Arrangements can be made with the responsible undertakers. This is, however, not usually feasible over longer routes or where there are many lines involved. It is usually impossible to do anything to raise low bridges, but steel gantries with bolted connections can sometimes be temporarily lifted.

9.2.3 Although there is no legal limit on the travelling height of a load, the Department for Transport does advise hauliers to inform the Regional Electricity Company's (REC), Openreach and any other companies with overhead service lines, of the route of proposed movements with a travelling height in excess of 5.0 metres. This enables arrangements to be made for temporary or permanent re-arrangement of facilities.

9.2.4 It is recommended that relevant statutory undertakers are approached to confirm recorded and safe height clearances for all wires above the often referred to high load cut off point of 16' 6" (5.03m). Even where a line is of a given height it does not mean that high loads will automatically be permitted to pass underneath due to flashover and the safe height clearance requirements of the line owner.

9.2.5 The large elements required for the Proposed Development should be able to be carried at below 5.03m and therefore no specific difficulties with overhead wires are envisaged.



9.3 Proposed AIL Access Route

- 9.3.1 It is considered that for the purpose of conveyance of AILs the New Bridge Lane access to the EfW CHP Facility Site will be used.
- 9.3.2 It is assumed for the purpose of this CTMP that all abnormal loads would originate from a key port of arrival into the UK due to the specific engineering requirements of elements of the EfW CHP Facility. Lowestoft port has been identified as the suitable candidate port of entry for Abnormal Load deliveries, however when the final port or ports of entry are known this will be recorded within the final CTMP. Notwithstanding, due to the location of the Proposed Development the A47 will form a key part of any route. Agreement for the movement of all AILs required to construct the Proposed Development will be sought with relevant local and strategic highways authorities as well as the relevant police force(s) before movements can commence.
- 9.3.3 For the purpose of this assessment Lowestoft port has been identified as suitable for the delivery and transshipment of abnormal loads. Lowestoft port is the closest port to the Proposed Development. The port can be accessed via Commercial Road from the A47 or directly from the Port at a sliproad to the A47 northbound just south of the junction with Commercial Road. Commercial Road has a junction with the A47 (Station Square) in Lowestoft town centre.
- 9.3.4 The location of the port will require the abnormal load vehicle to route through urban areas within Folkstone and Great Yarmouth on the A12/A47. The A12 and A47 is part of the SRN all the way to Lowestoft town centre and the entry to the port.
- 9.3.5 NH have heavy and high routes for the conveyance of AILs. A key route locally is the Heavy Load Route 100 which runs from the Sizewell Nuclear Power station and north to Lowestoft. From here AILs accessing Sizewell had used the A12/A47 for connections back to the UK Motorway Network. It is proposed that AILs for the Proposed Development would also use the same route along the A12/A47 to Wisbech.
- 9.3.6 This section and [Table 6A.7 Route from Lowestoft Port to Medworth EfW CHP Facility Site](#) sets out the proposed routing of the AIL between Lowestoft Port and the New Bridge Lane Access. The Table sets out the sections and junctions that are required to be passed through and any observations of potential constraints. The Proposed AIL Route is also shown in **Figure 9.1: Proposed AIL Access Route** to this Outline CTMP.

Table 6A.7 Route from Lowestoft Port to Medworth EfW CHP Facility Site

ID	Section or Turn	Length	Notes
1	TURN - AILs exit the port using on slip road north on to A47 at Station Square	-	Large junction with A12 – temporary removal of lighting and signals.
2	SECTION – Port Exit/A12 Junction to A12/Gordon Road/Whapload Road junction	0.65km	Wide carriageway in Lowestoft town centre with ghost right turn island in centre of carriageway. No significant constraints



ID	Section or Turn	Length	Notes
			although some street furniture may need to be removed
3	TURN – A12 Ahead to A12 at A12/Gordon Road/Whapload Road junction	-	Large roundabout – overrun areas on the centre island. No conveyance issues.
4	SECTION - A12/Gordon Road/Whapload Road junction to A12/St Peter's Street/Dukes Head Street/Tennyson Road junction	0.45km	Wide carriageway in urban area of Lowestoft. No significant constraints.
5	TURN – A12 ahead to A47 at A12/A47/St Peter's Street/Dukes Head Street/Tennyson Road junction	-	Large roundabout – overrun areas on the centre island. No conveyance issues.
6	SECTION - A12/A47/St Peter's Street/Dukes Head Street/Tennyson Road junction to A47/A1117/Leisure Way junction	3km	7m to 7.5m carriageway through residential areas of Lowestoft. No significant constraints
7	TURN – A47 ahead to A47 at A47/A1117/Leisure Way junction	-	Large roundabout – overrun areas on the centre island. No conveyance issues.
8	SECTION - A47/A1117/Leisure Way junction to A47/Millennium Way/Blunderstone Road/B1385 junction	0.62km	7m to 7.5m carriageway through residential/rural areas of north Lowestoft. No significant constraints.
9	TURN – A47 Ahead to A47 at A47/Millennium Way/Blunderstone Road/B1385 junction	-	Very large roundabout – overrun areas on the centre island. No conveyance issues.
10	SECTION - A47/Millennium Way/Blunderstone Road/B1385 junction to A47/B1375 junction	1.07km	Dual Carriageway. No conveyance Issues.
11	TURN - A47 Ahead to A47 at A47/B1375 junction	-	Very large roundabout – overrun areas on the centre island. No conveyance issues.
12	SECTION - A47/B1375 junction to A47/Hopton Village Access junction	2.3km	Dual Carriageway. No conveyance Issues.
13	TURN – A47 Ahead to A47 at A47/Hopton Village Access junction	-	Very large roundabout – overrun areas on the centre island. No conveyance issues.
14	SECTION - A47/Hopton Village Access junction to A47/Beaufort Way/Links Road junction	2.01km	Dual Carriageway. No Conveyance Issues.



ID	Section or Turn	Length	Notes
15	TURN – A47 Ahead to A47 at A47/Beaufort Way/Links Road junction	-	Very large roundabout – overrun areas on the centre island. No conveyance issues.
16	SECTION - A47/Beaufort Way/Links Road junction to A47/B1370 junction	1.22km	Dual Carriageway in residential southern Gorleston-on-Sea. No Conveyance Issues.
17	TURN – A47 Ahead to A47 at A47/B1370 junction	-	Large roundabout – overrun areas on the centre island. No conveyance issues.
18	SECTION - A47/B1370 junction to A47/Victoria Road Junction	0.26km	Dual Carriageway in residential southern Gorleston-on-Sea. No conveyance Issues.
19	TURN – A47 left turn to A47 at A47/Victoria Road Junction	-	Large roundabout – overrun areas on the centre island. No conveyance issues.
20	SECTION - A47/Victoria Road Junction to A47/William Adams Way junction	2.58km	Dual Carriageway in residential southern Great Yarmouth. Three overbridges (one pedestrian and two highway) with no posted high restrictions.
21	TURN – A47 ahead to A47 at A47/William Adams Way Junction	-	Large roundabout – overrun areas on the centre island. No conveyance issues.
22	SECTION - A47/William Adams Way Junction to A47/A1243 Junction	0.84km	Dual Carriageway in residential southern Great Yarmouth. One pedestrian overbridge with no posted high restrictions.
23	TURN - A47 ahead to A47 at A47/A1243 Junction	-	Large roundabout – overrun areas on the centre island. No conveyance issues.
24	SECTION - A47/A1243 Junction to A47/A149/Runham Road junction	1.93km	Single Carriageway in great Yarmouth. Road crosses River Yare on draw bride with no posted high restriction
25	TURN – A47 Left to A47 at A47/A149/Runham Road junction	-	Large roundabout – overrun areas on the centre island. No conveyance issues.
26	SECTION - A47/A149/Runham Road junction to A47/A1064/New Road junction	11.71km	Single Carriageway 7 to 7.5m wide. No conveyance issues.
27	TURN – A47 left to A47 at A47/A1064/New Road junction	-	Large roundabout – overrun areas on the centre island. No conveyance issues.
28	SECTION – A47/A1064/New Road junction to A47/Cucumber Lane junction	9.03km	Single Carriageway section 7 to 7.5m wide and dual carriageway section. No conveyance issues.



ID	Section or Turn	Length	Notes
29	TURN – A47 ahead to A47 at A47/Cucumber Lane junction		Large roundabout – overrun areas on the centre island. No conveyance issues.
30	SECTION – A47/Cucumber Lane junction to A47/Dearham Road/Church Lane	24.34km	Dual Carriageway at A47 (Norwich Southern Bypass). Numerous road overbridges with no posted height restrictions.
31	TURN – A47 Ahead to A47 at A47/Dearham Road/Church Lane junction	-	Large roundabout – overrun areas on the centre island. No conveyance issues.
32	SECTION - A47/Dearham Road/Church Lane junction to A47/Norwich Road junction	2.03km	Single Carriageway section 7 to 7.5m wide through rural area. No conveyance issues.
33	TURN – A47 Ahead to A47 at A47/Norwich Road junction		Large roundabout – overrun areas on the centre island. No conveyance issues.
34	SECTION – A47/Norwich Road junction to A47/Norwich Road junction (Swaffham)	28.77km	Single Carriageway section 7 to 7.5m wide and dual carriageway section. No conveyance issues.
35	TURN – A47 Ahead to A47 at A47/Norwich Road junction (Swaffham)		Large roundabout – overrun areas on the centre island. No conveyance issues.
36	SECTION - A47/Norwich Road junction (Swaffham) to A47/A1122 Junction	6.32km	Single Carriageway section 7 to 7.5m wide and dual carriageway section. No conveyance issues.
37	TURN – A47 ahead to A47 - A47/A1122 Junction		Large roundabout – overrun areas on the centre island. No conveyance issues.
38	SECTION - A47/A1122 Junction to A47/A10 Junction	18.39km	Single Carriageway section 7 to 7.5m wide in a rural area passing through some villages. No conveyance issues.
39	TURN – A47 ahead to A47 at A47/A10 Junction	-	Large roundabout – overrun areas on the centre island. No conveyance issues.
40	SECTION – A47/A10 junction to A47/A17 junction	2.89km	Dual Carriageway section through Kings Lynn. No conveyance issues.



ID	Section or Turn	Length	Notes
41	TURN – A47 left to A47 at A47/A17 junction	-	Large roundabout – overrun areas on the centre island. No conveyance issues.
42	SECTION – A47/A17 to A47/Main Road junction	3.78km	Single Carriageway section 7 to 7.5m wide in a rural area passing through some villages. No conveyance issues.
43	TURN – A47 ahead to A47 at A47/Main Road junction	-	Large roundabout – overrun areas on the centre island. No conveyance issues.
44	SECTION – A47/Main Road junction to A47/Lynn Road (B198)	9.81km	Dual Carriageway section. No conveyance issues.
45	TURN – A47 ahead to A47 - to A47/Lynn Road (B198) junction	-	Large roundabout – overrun areas on the centre island. No conveyance issues.
46	SECTION – A47/Lynn Road (B198) junction to A47/A1101 (Elm High Road) Junction	5.02km	Single Carriageway section 7 to 7.5m wide in a rural area passing east of Wisbech.
47	TURN – A47 ahead to A47 at A47/A1101 (Elm High Road) Junction	-	Large roundabout – overrun areas on the centre island. No conveyance issues.
48	SECTION - A47/A1101 (Elm High Road) Junction to A47/Cromwell Road Junction	2.41km	Single Carriageway section 7 to 7.5m wide in a rural area passing south of Wisbech.
49	TURN – A47 right to Cromwell Road at A47/Cromwell Road Junction	-	Large roundabout – overrun areas on the centre island. No conveyance issues.
50	SECTION - A47/Cromwell Road Junction to Cromwell Road/New Bridge Lane Junction	0.64km	Single Carriageway section 7 to 7.5m wide in south Wisbech. No Conveyance Issues.
51	TURN – Cromwell Road right to New Bridge Lane at Cromwell Road/New Bridge Lane Junction	-	Conveyance of Abnormal Loads in this location may require improvement works.

9.3.7 The route set out above is characterised by wide single carriageway or dual carriageway elements of the A47 with numerous turns at roundabout junctions which would allow for the conveyance of the AILs.

9.3.8 No height or weight restrictions are posted on the route. Checks with highways Stakeholders on the heights of all bridges identified should however be undertaken in advance of construction.

9.3.9 An initial Swept Path Assessment (SPA) has been undertaken and presented as **Figure 9.2 AIL SPA – New Bridge Lane/Cromwell Road** to indicate the need for



any improvements to allow the conveyance of the loads. This has been based on a worst-case delivery vehicle arrangement for the largest component needed for the construction of the Proposed Development. It is considered that when conveyance times/routes/loads are confirmed during the construction process the delivery vehicle used would be more manoeuvrable than that used for the SPA in this CTMP, potentially making use of rear wheeled steered arrangements.

9.3.10 However, with the worst-case arrangement modelled, the vehicle can access New Bridge Lane from Cromwell Road within the existing highway boundary. There would be a requirement for verge and footpath overrun and potentially the removal of some trees on the south-east side of the junction which if required would be replanted following the works. Traffic management under police escort may be necessary prior to movements as it is likely that there will be locations where the full extent of the carriageway will be required for AILs to transit, especially on single carriageway sections of the road network. The exact requirements will be determined when AIL delivery requirements are confirmed and an appointed haulage contractor confirms the street furniture removal requirements, escorts, movement timings and other logistical details prior to delivery.



10. Access Improvements

- 10.1.1 The Applicant has proposed Access Improvements to New Bridge Lane (see **ES Chapter 3 Description of the Proposed Development (Volume 6.2) [APP-030] Section 3.4** and **Figures 3.6 and 3.19 (Volume 6.3) [APP-0-049]** and Algores Way. These drawings have been revised in response to comments received from CCC in its relevant representation. The Applicant has prepared drawings to show the construction accesses from Weasenhams Lane into the CHP Connection Corridor. The works will be undertaken consistent with the construction programme and the detailed drawings which will be submitted to the relevant highway authority for its approval prior to these access works commencing. The Access Improvements are shown as **Figure 10.1 to 10.3** to this document.



Figures

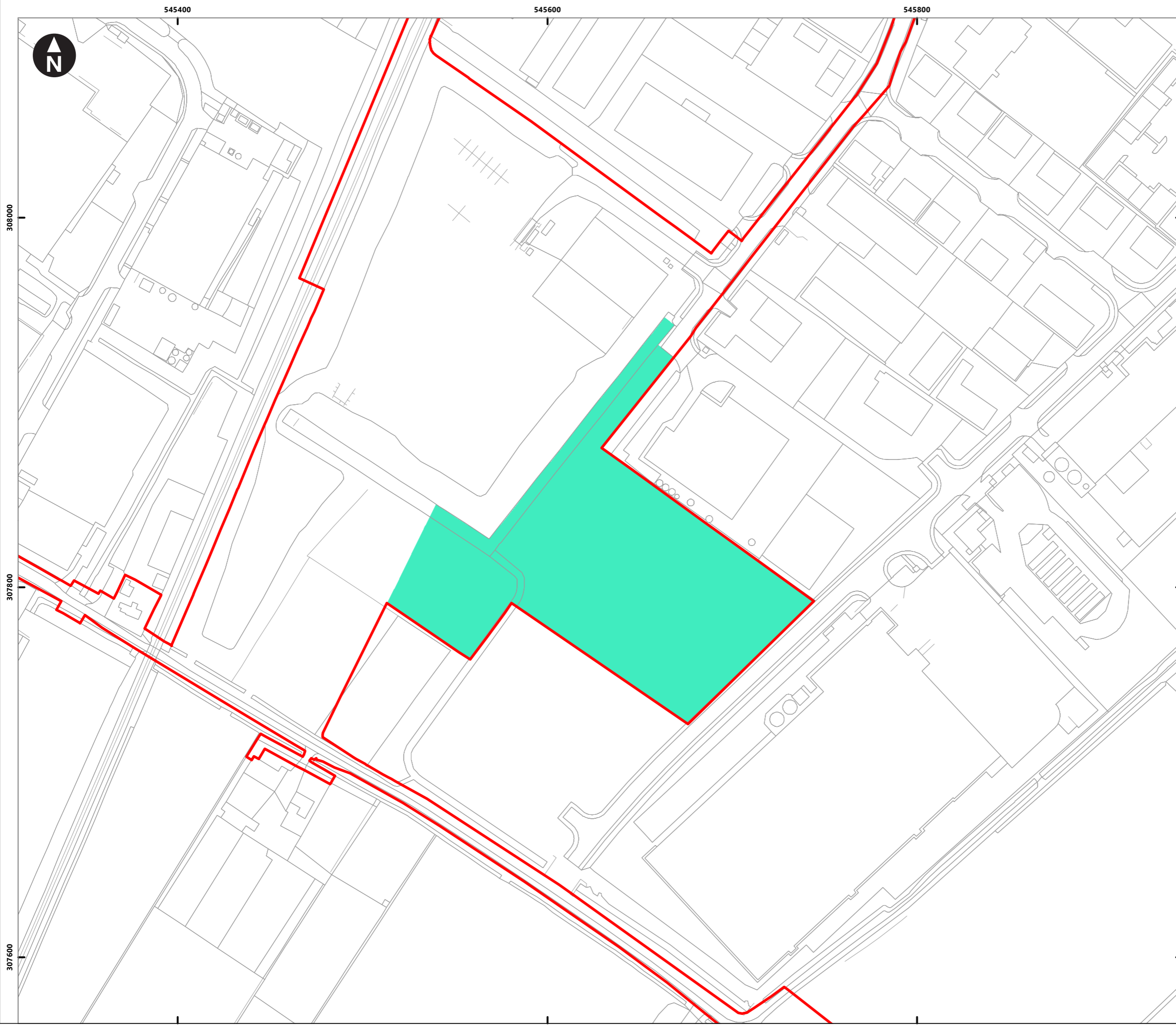

Key

- Order limits
- Temporary Construction Compound

0 20 40 60 80 100 120 m
Scale at A3: 1:2,000
© Crown Copyright. All rights reserved. Licence number AL100001776.

Client



Medworth CHP Limited
Medworth Energy from Waste Combined Heat and Power Facility
Environmental Statement
Appendix 6A - Outline Construction Traffic Management Plan

Figure 2.1
Proposed Construction Compound

June 2022



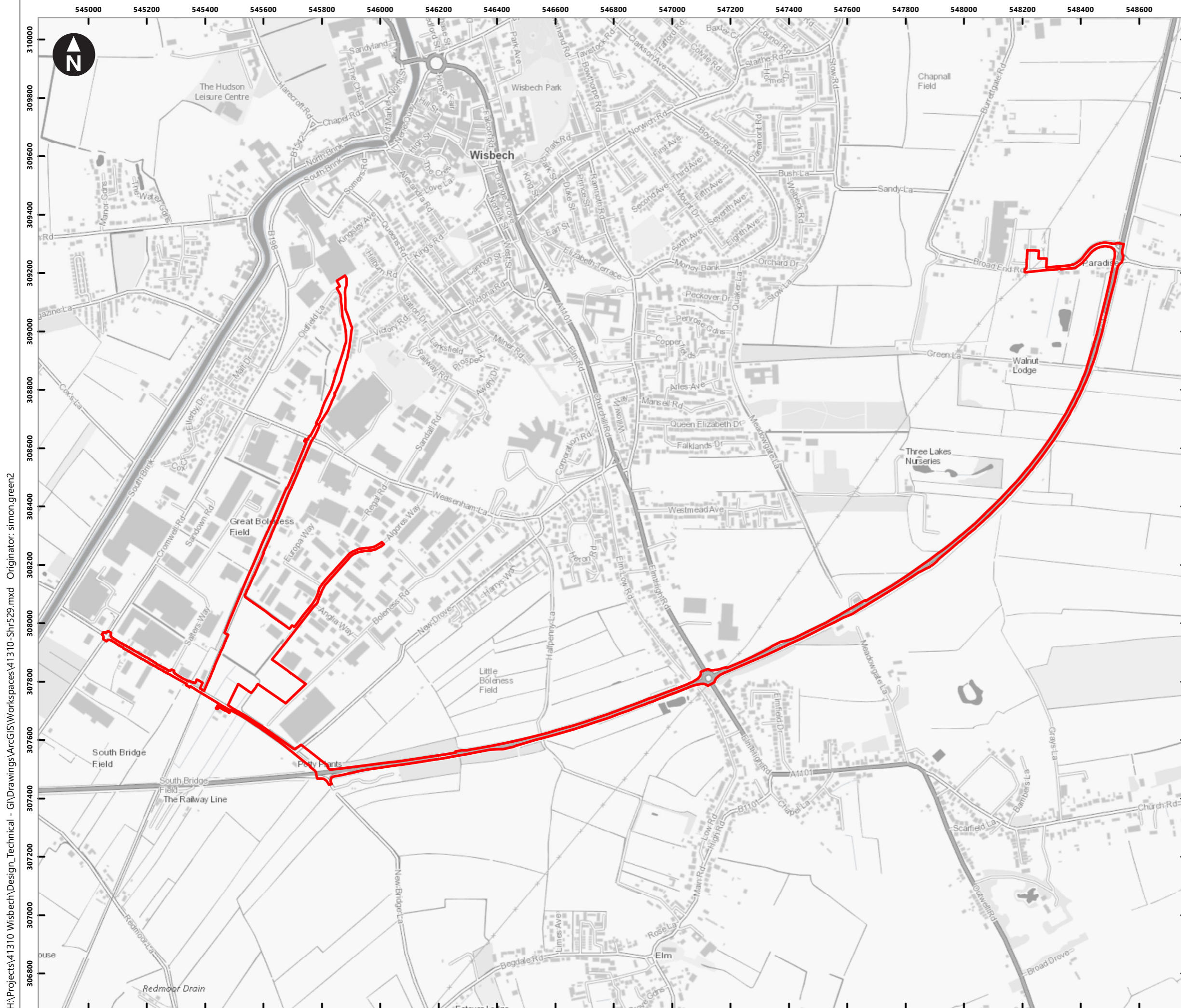

Key

Order limits

0 200 400 600 m

Scale at A3: 1:12,500

© Crown Copyright. All rights reserved. Licence number AL100001776.



Medworth CHP Limited
 Medworth Energy from Waste Combined Heat and Power Facility DCO
 Environmental Statement
 Appendix 6A Outline Construction Traffic Management Plan

Figure 2.2
Order limits





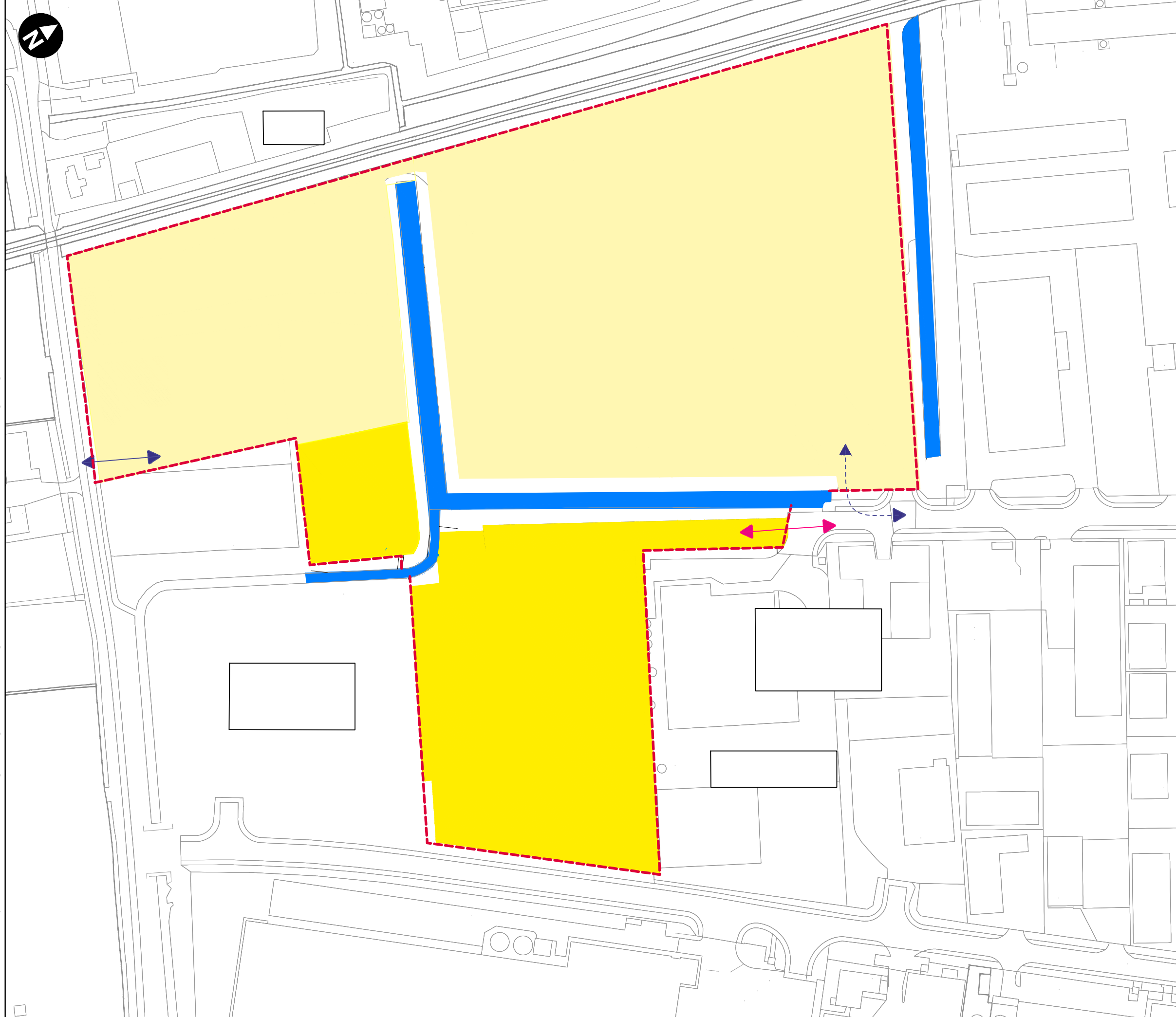

June 2022

● ● ●

H:\Projects\41310 Wisbech\Design_Technical - GI\Drawings\ArcGIS\Workspaces\41310-Shr529.mxd Originator: simon.green2

H:\SAL-FS12-SHARED\Projects\41310 Wisbech\Deliver Stage\Design\Technical\Drawings\ACAD\41310-WOOD-XX-XX-FG-OT-0002_S0_P01.1.dwg Originator: ADAM.GUY



- KEY
-  Construction compound fence (1.8 to 2.4m (h))
 -  Temporary construction compound
 -  EFW site area
 -  Primary HGV entrance/exit
 -  Secondary HGV entrance/exit
 -  Personnel entrance

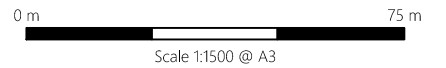

© Crown copyright and database rights 2021 Ordnance Survey 0100031673



Medworth CHP Limited
 Medworth Energy from Waste Combined Heat and Power Facility DCO
 Environmental Statement
 Chapter 3 - Description of the Proposed Development

Figure 3.1
Proposed EFW CHP Facility construction accesses

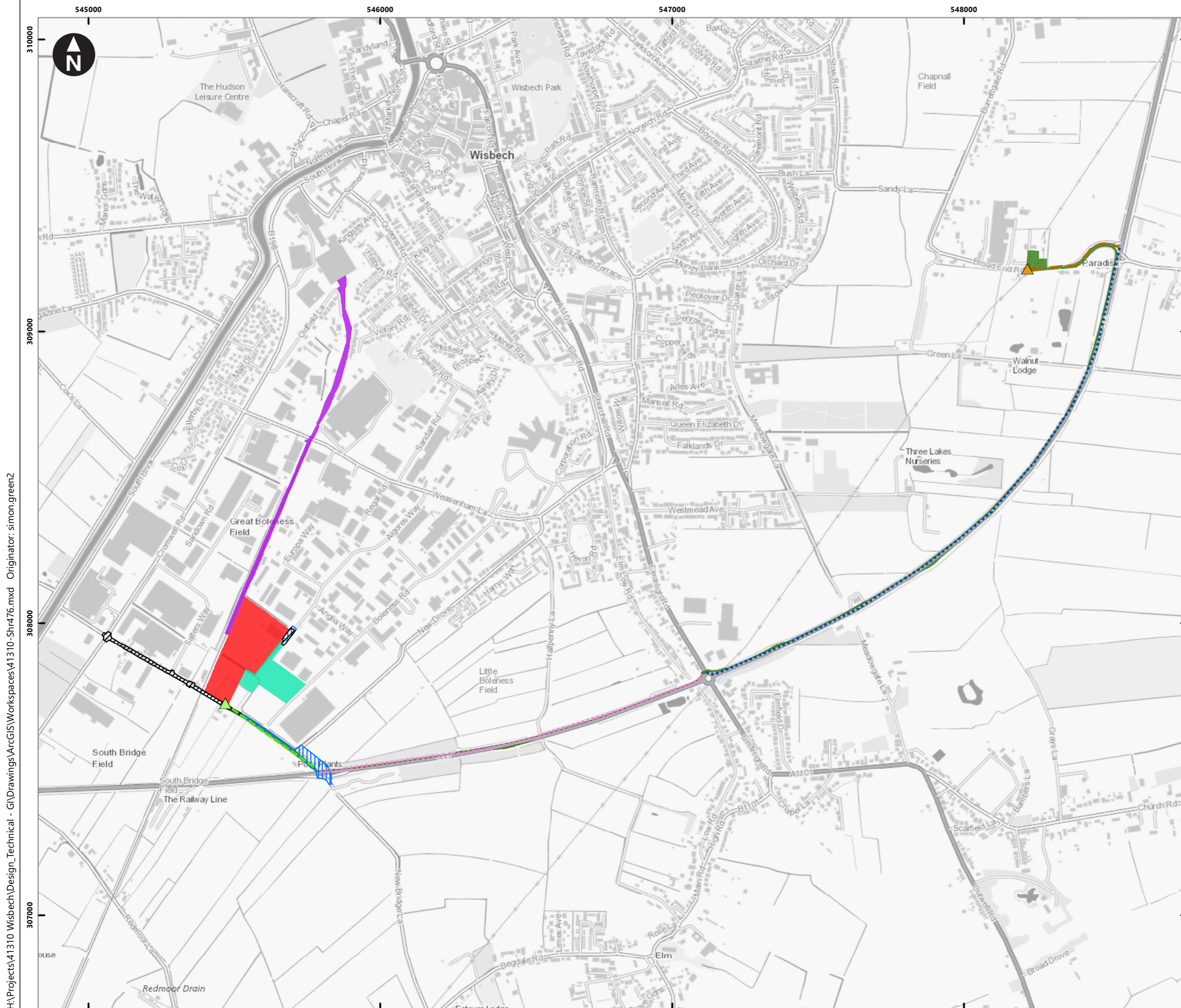

- Key
- EfW CHP Facility Site
 - CHP Connection
 - Temporary Construction Compound
 - Grid Connection
 - Access Improvements
 - Water Connections
 - A47 Section 1
 - A47 Section 2
 - Broadend Road
 - New Bridge Lane Cable Section
 - ▲ New Bridge Lane Access
 - ▲ Walsoken Substation Access

0 100 200 300 400 500 600 700 m
 Scale at A3: 1:12,500
 © Crown Copyright. All rights reserved. Licence number AL100001776.



Medworth CHP Limited
 Medworth Energy from Waste Combined Heat and Power Facility
 Environmental Statement
 Appendix 6A - Outline Construction Traffic Management Plan
Figure 3.2
Underground Cable Construction Accesses

June 2022

H:\Projects\41310 Wisbech\Design_Technical - G:\Drawings\ArcGIS\Workspaces\41310-Shr476.mxd Originator: simon.green2

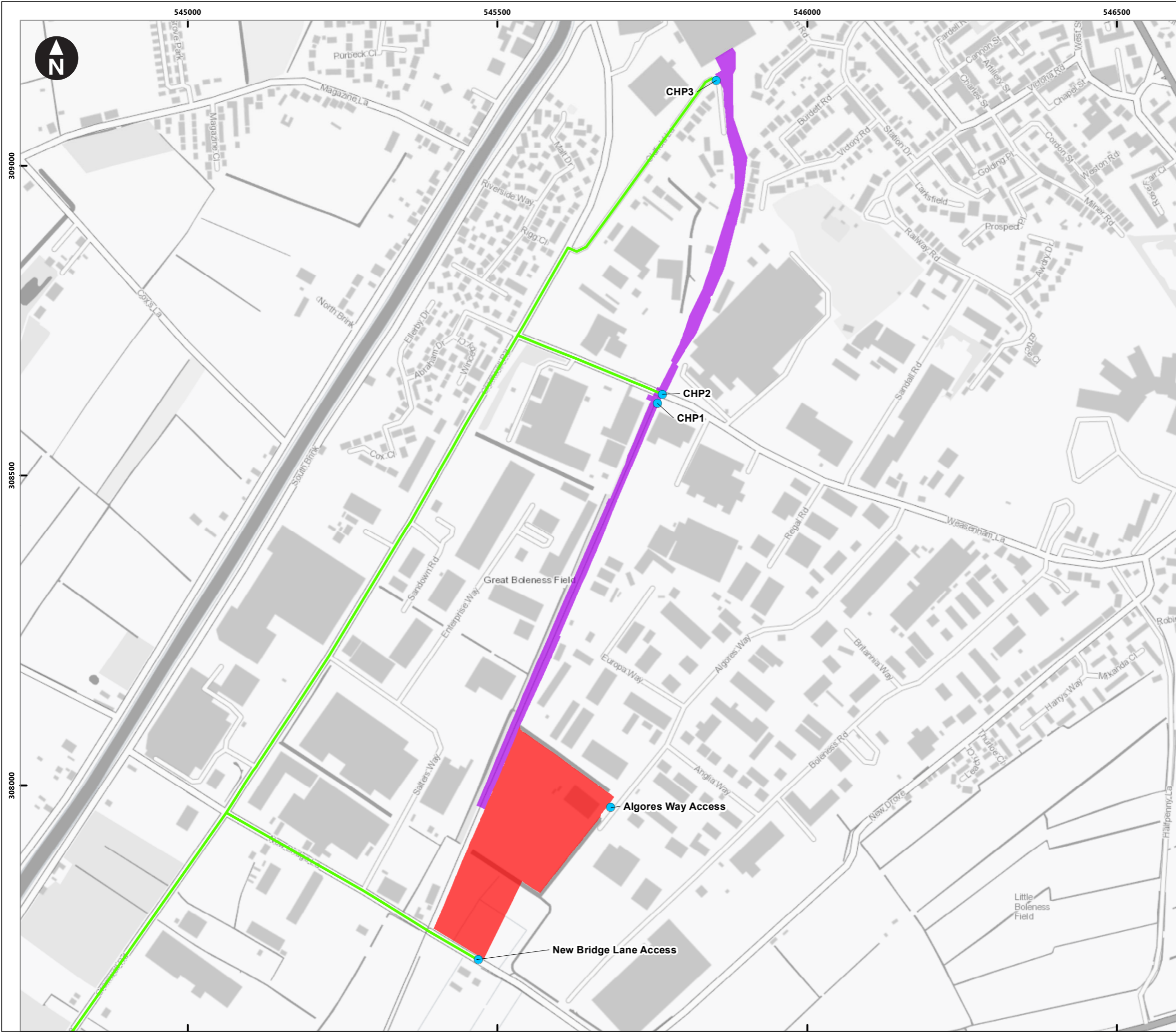

- Key
- EFW CHP Facility Site
 - CHP Connection
 - Proposed Access Routes
 - CHP Connection Construction Accesses

0 50 100 150 200 250 300 350 m
 Scale at A3: 1:6,000
 © Crown Copyright. All rights reserved. Licence number AL100001776.



Medworth CHP Limited
 Medworth Energy from Waste Combined Heat and Power Facility DCO
 Environmental Statement
 Appendix 6A Outline Construction Traffic Management Plan

Figure 3.3
Proposed CHP Connection

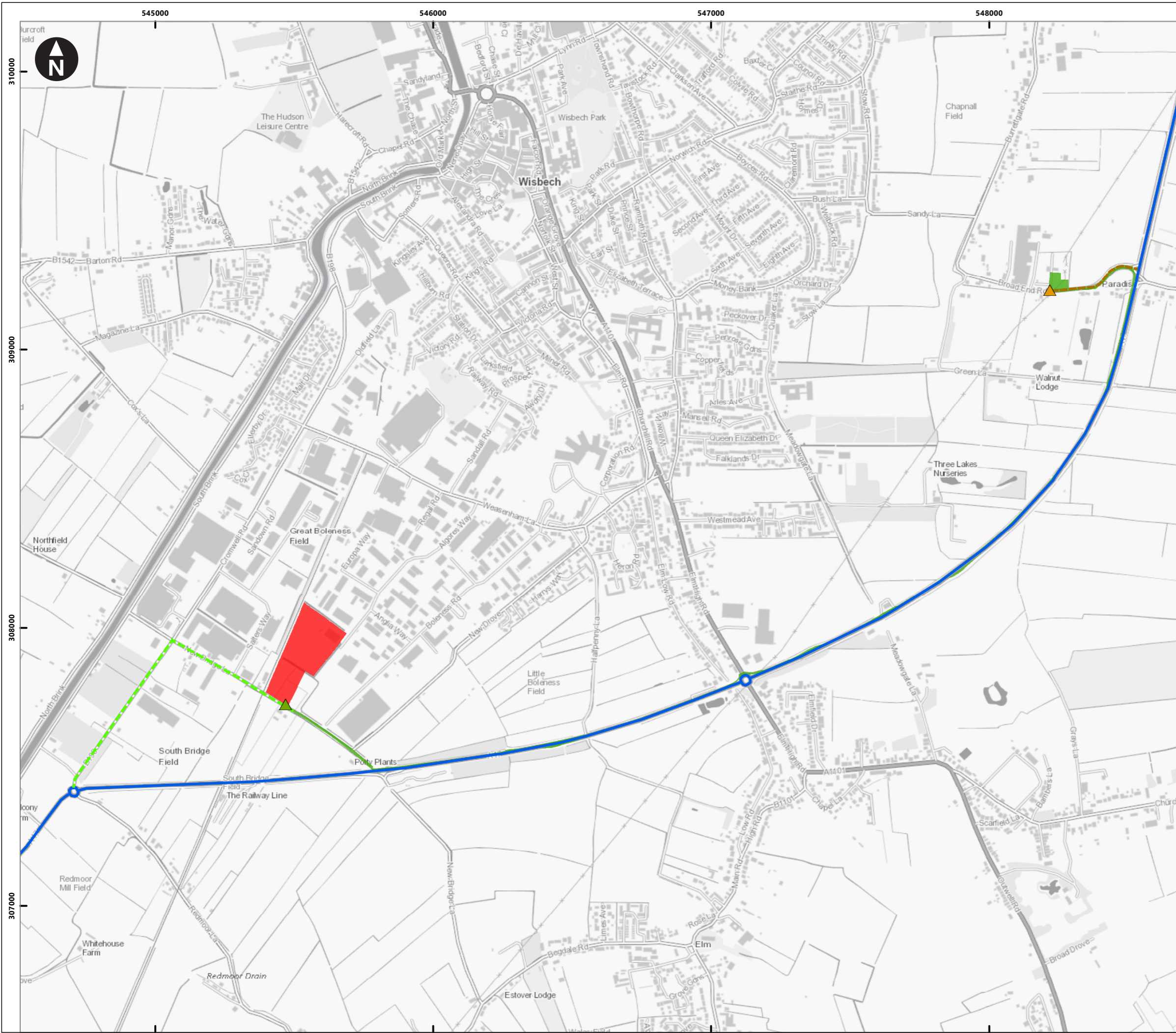

- Key
- EFW CHP Facility Site
 - Grid Connection
 - Strategic Road Network - A47
 - Broadend Road
 - Cromwell Road to New Bridge Lane
 - New Bridge Lane Access
 - Walsoken Substation Access

0 100 200 300 400 500 600 700 800 m
 Scale at A3: 1:13,368
 © Crown Copyright. All rights reserved. Licence number AL100001776.



Medworth CHP Limited
 Medworth Energy from Waste Combined Heat and Power Facility
 Environmental Statement
 Appendix 6A - Outline Construction Traffic Management Plan

Figure 4.1
Grid Connection Access Strategy

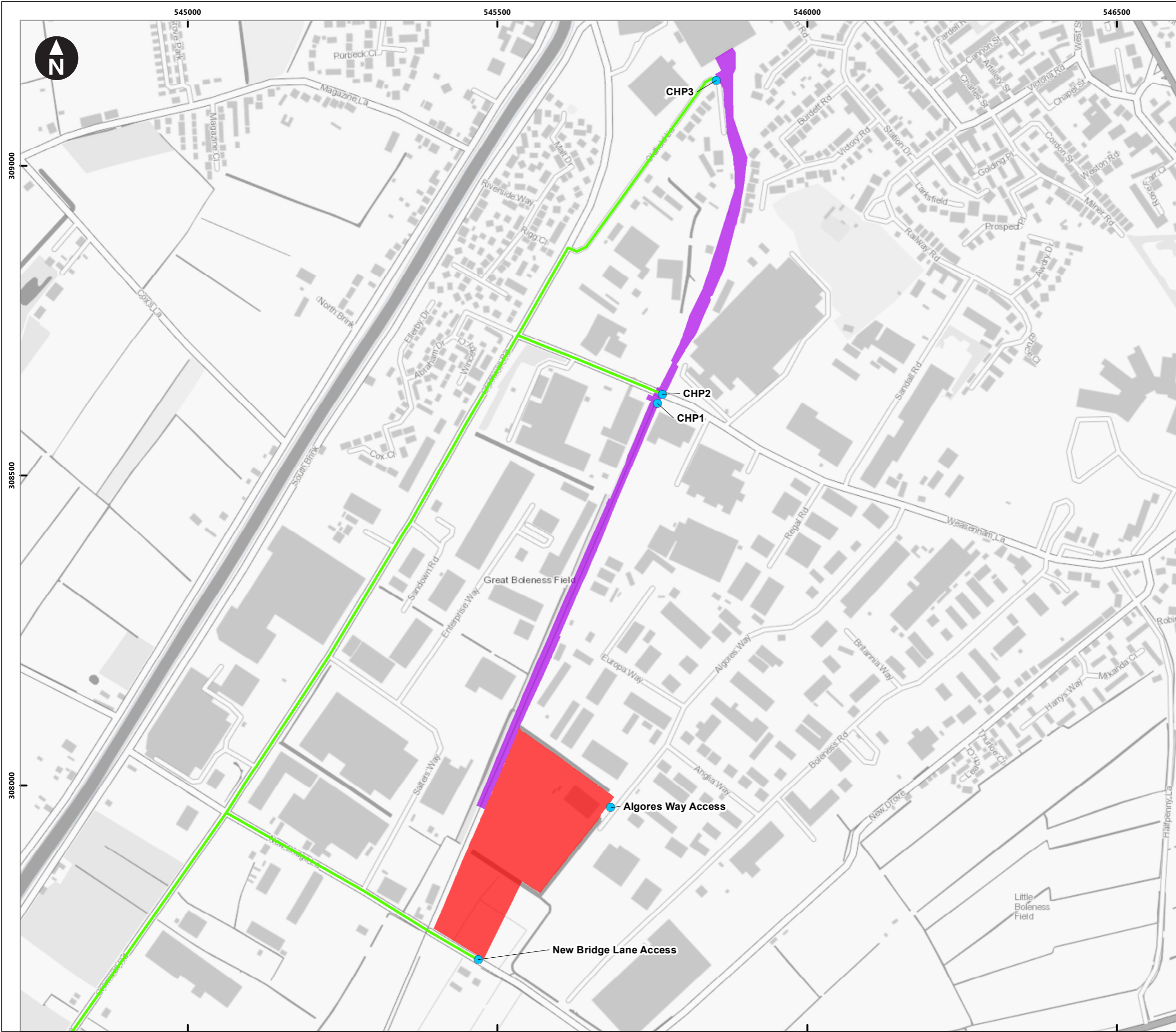

Key

- EFW CHP Facility Site
- CHP Connection
- Proposed Access Routes
- CHP Connection Construction Accesses

0 50 100 150 200 250 300 350 m
 Scale at A3: 1:6,000
 © Crown Copyright. All rights reserved. Licence number AL100001776.

Client



Medworth CHP Limited
 Medworth Energy from Waste Combined Heat and Power Facility
 Environmental Statement
 Appendix 6A - Outline Construction Traffic Management Plan

Figure 4.2
CHP Connection Access Strategy

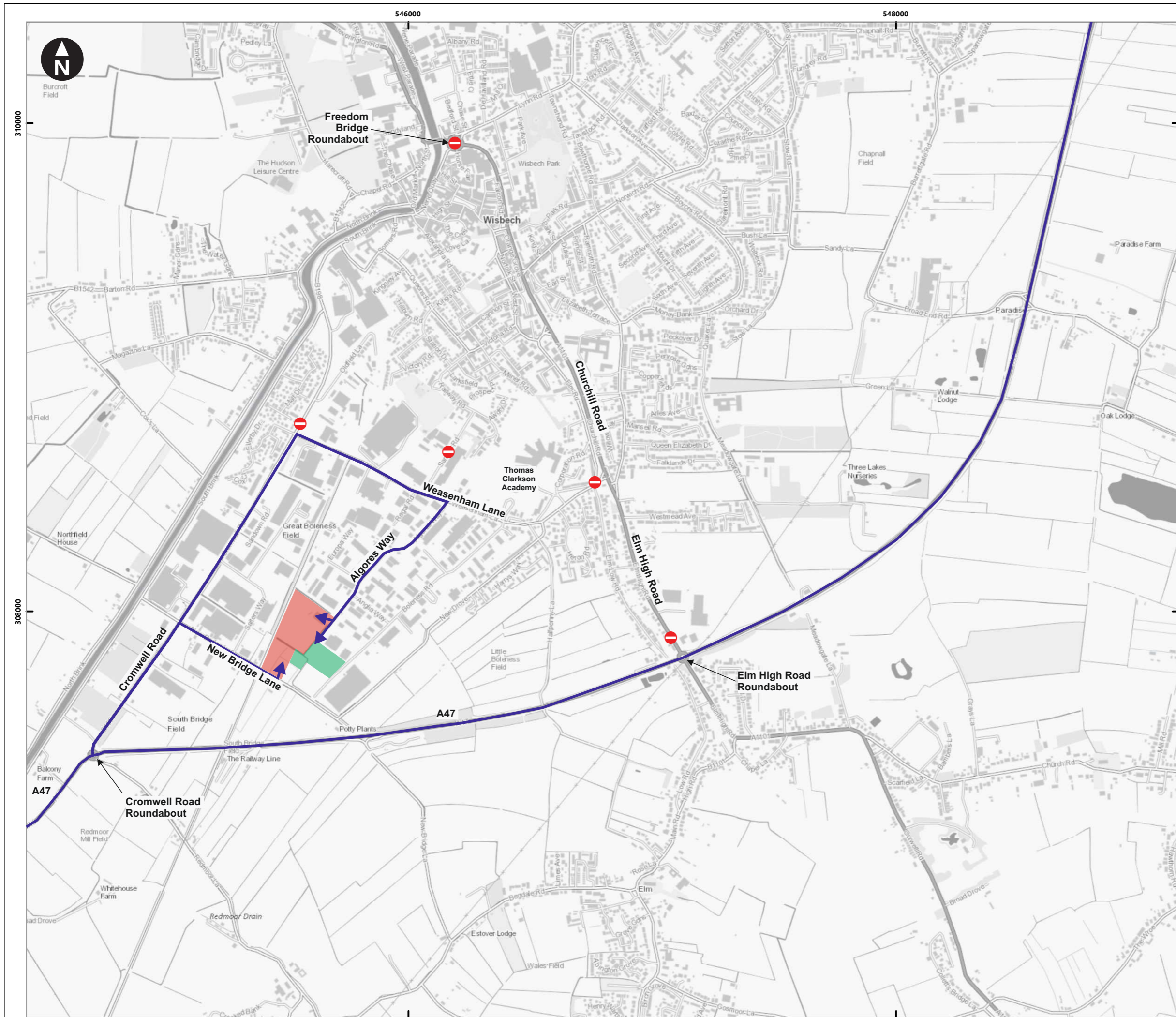

Key

- EFW CHP Facility Site
- Temporary Construction Compound
- HGV access routes
- Construction HGV route restrictions (unless local goods and services)

Notes:

Aim of the construction traffic routes and restrictions:
HGV traffic to use the access routes identified, thereby avoid unnecessary routes through Wisbech town centre and local villages.

HGV access:
HGV traffic shall access the EFW CHP Facility Site and TCC from the A47 (and its connecting routes) via Cromwell Road and either:
1) New Bridge Lane; or
2) Weasenham Lane and Algores Way.

HGV routing exemptions:
1) Supply of local goods and services
2) In the event of matters beyond the control of the Applicant or its EPC Contractor(s), such as, temporary road closures, HGV route restrictions would be temporarily suspended.

Construction staff access:
Staff traffic shall access the EFW CHP Facility Site and TCC via Algores Way and are not subject to route restrictions.

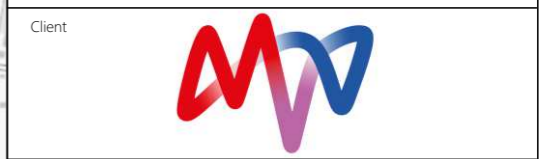
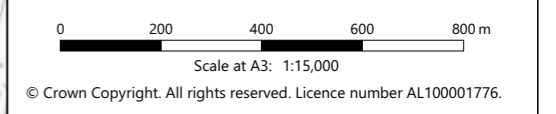

Medworth CHP Limited
Medworth Energy from Waste Combined Heat and Power Facility DCO
Environmental Statement
Appendix 6A Outline Construction Traffic Management Plan

Figure 4.3
EfW CHP Facility and TCC construction traffic routes and restrictions

H:\Projects\41310 Wisbech\Design_Technical - GIS\Drawings\ArcGIS\Workspaces\41310-Shr479.mxd Originator: simon.green2



Key

- EFW CHP Facility Site
- Staff Travel Distribution Network
- Distribution point

0 500 1,000 1,500 2,000 2,500 3,000m
Scale at A3: 1:50,000
© Crown Copyright. All rights reserved. Licence number AL100001776.





Medworth CHP Limited
Medworth Energy from Waste Combined Heat and Power Facility
Environmental Statement
Appendix 6A - Outline Construction Traffic Management Plan

Figure 5.1
Staff Distribution Points

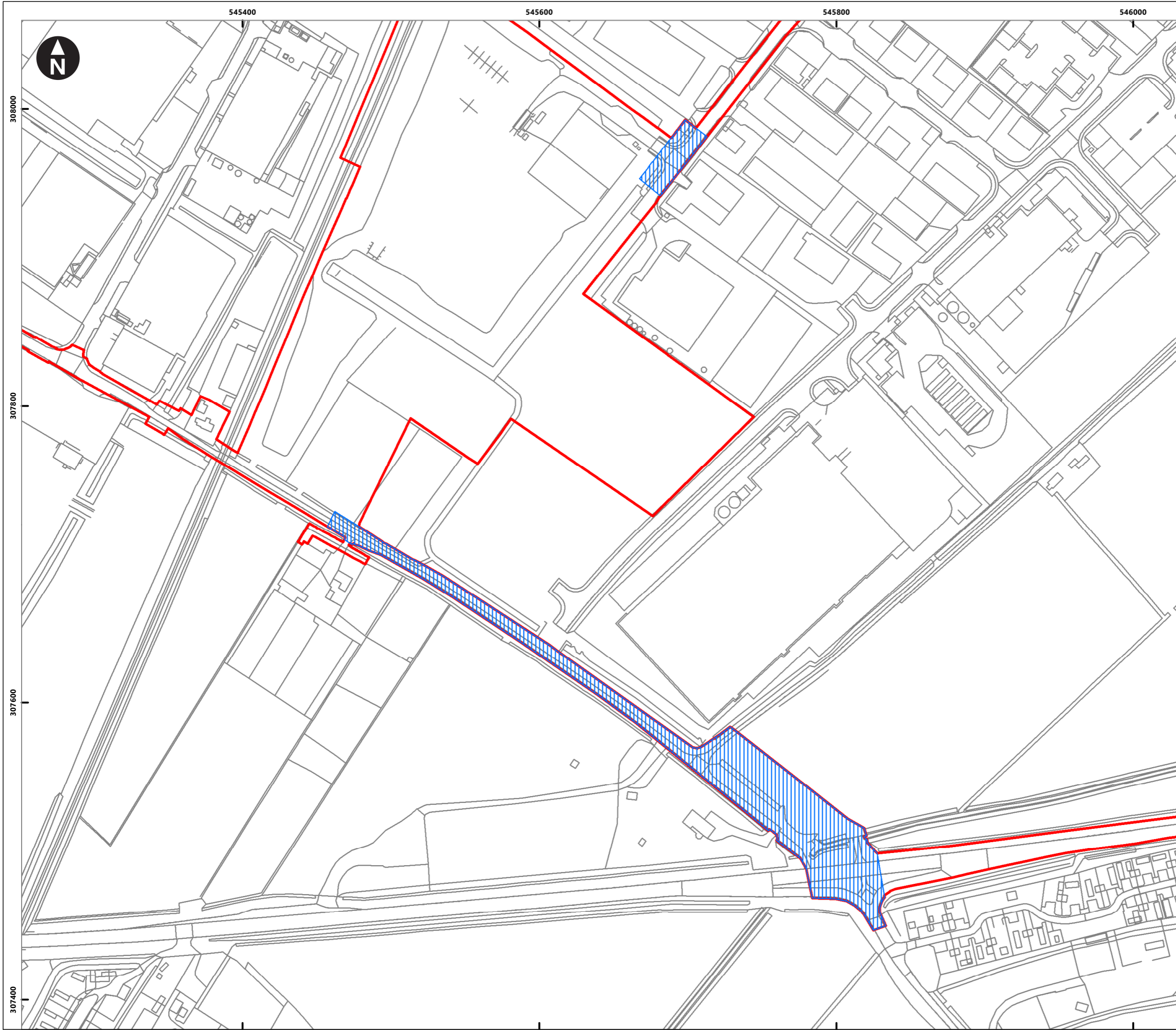
June 2022



Key

-  Order limits
-  Water Connections

0 20 40 60 80 100 120 140 m
Scale at A3: 1:2,500
© Crown Copyright. All rights reserved. Licence number AL100001776.



Medworth CHP Limited
Medworth Energy from Waste Combined Heat and Power Facility DCO
Environmental Statement
Appendix 6A Outline Construction Traffic Management Plan
Figure 6.1
Water Connections layout

Traffic control by portable traffic signals

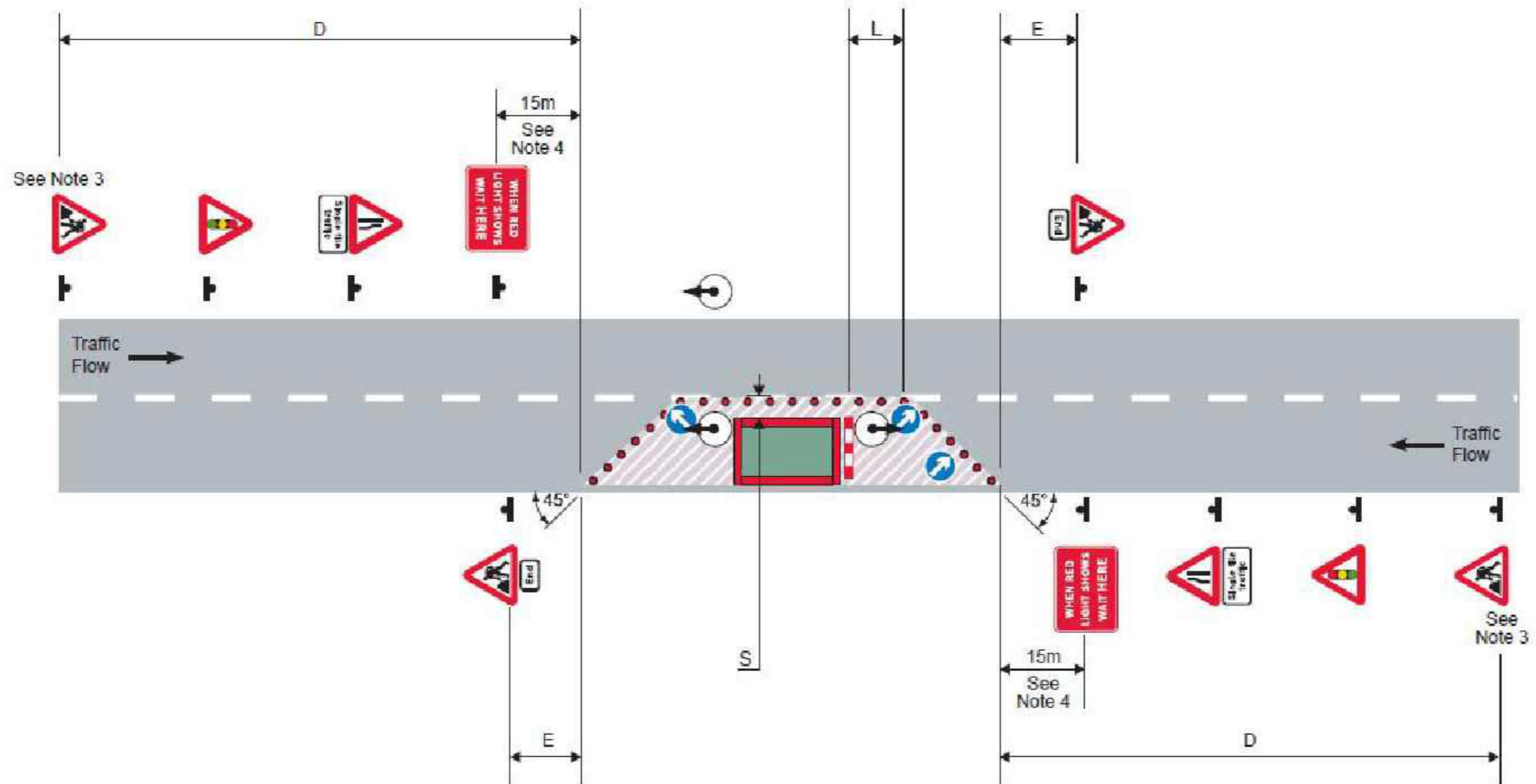

Setting out site

(Distances in metres unless stated otherwise, numbers are minimum numbers)

Type of road	Minimum visibility distance to first sign	D Distance from first sign to start of lead-in taper	Taper length No of cones No of lights	Lead-in taper Width of works including sideways safety zone							S Minimum width of sideways safety zone	E Distance from last cone to End of works sign	Minimum size of signs (mm)
				1m	2m	3m	4m	5m	6m	7m			
Single carriageway – speed limit 30 mph or less	60	20 to 45	Taper length No of cones No of lights	13 4 –	26 4 –	39 6 –	52 7 –	65 9 –	78 10 –	91 12 –	0.5	10 to 30	600
Single carriageway – speed limit 40 mph	60	45 to 110	Taper length No of cones No of lights	20 4 3	40 6 5	60 8 7	80 10 9	100 13 12	120 15 14	140 17 16	0.5	30 to 45	750
Single carriageway – speed limit 50 mph or more	75	275 to 450	Taper length No of cones No of lights	25 4 3	50 7 6	75 10 9	100 13 12	125 15 14	150 18 17	175 21 20	1.2	30 to 45	750
All-purpose dual carriageway – speed limit 40 mph or less	60	110 to 275	Taper length No of cones No of lights	25 4 3	50 7 6	75 10 9	100 13 12	125 15 14	150 18 17	175 21 20	0.5	30 to 45	750

Speed limit mph	20	30	40	50	60
L Longways clearance	0.5	0.5	15	30	60

Speed limit mph	30 or less	40 or more
C Clearance to works vehicle	2	5

Notes

- For roads covered by this Code, the minimum height of cones is 450 mm where the speed limit is 40 mph or less, and 750 mm where the speed limit is 50 mph or more.
- The maximum spacing between cones in longitudinal lengths shall be 9 metres, but no fewer than two cones shall be used in any length between tapers.
- Lead-in tapers where two-way traffic control is used, and all exit tapers shall be at about 45° to the kerb line with cones spaced 1.2 metres apart maximum.
- In certain circumstances on congested roads with speed limits of 30 mph or less, the lead-in taper may be reduced to 45° (see page 19).
- The longways clearance (L) is the distance between the end of the lead-in taper and the first traffic barrier placed across the lane.

Client



Medworth CHP Limited
Medworth Energy from Waste Combined Heat and Power Facility DCO
Environmental Statement
Appendix 6A - Outline Construction Traffic Management Plan

Figure 7.1
Typical traffic management



June 2022

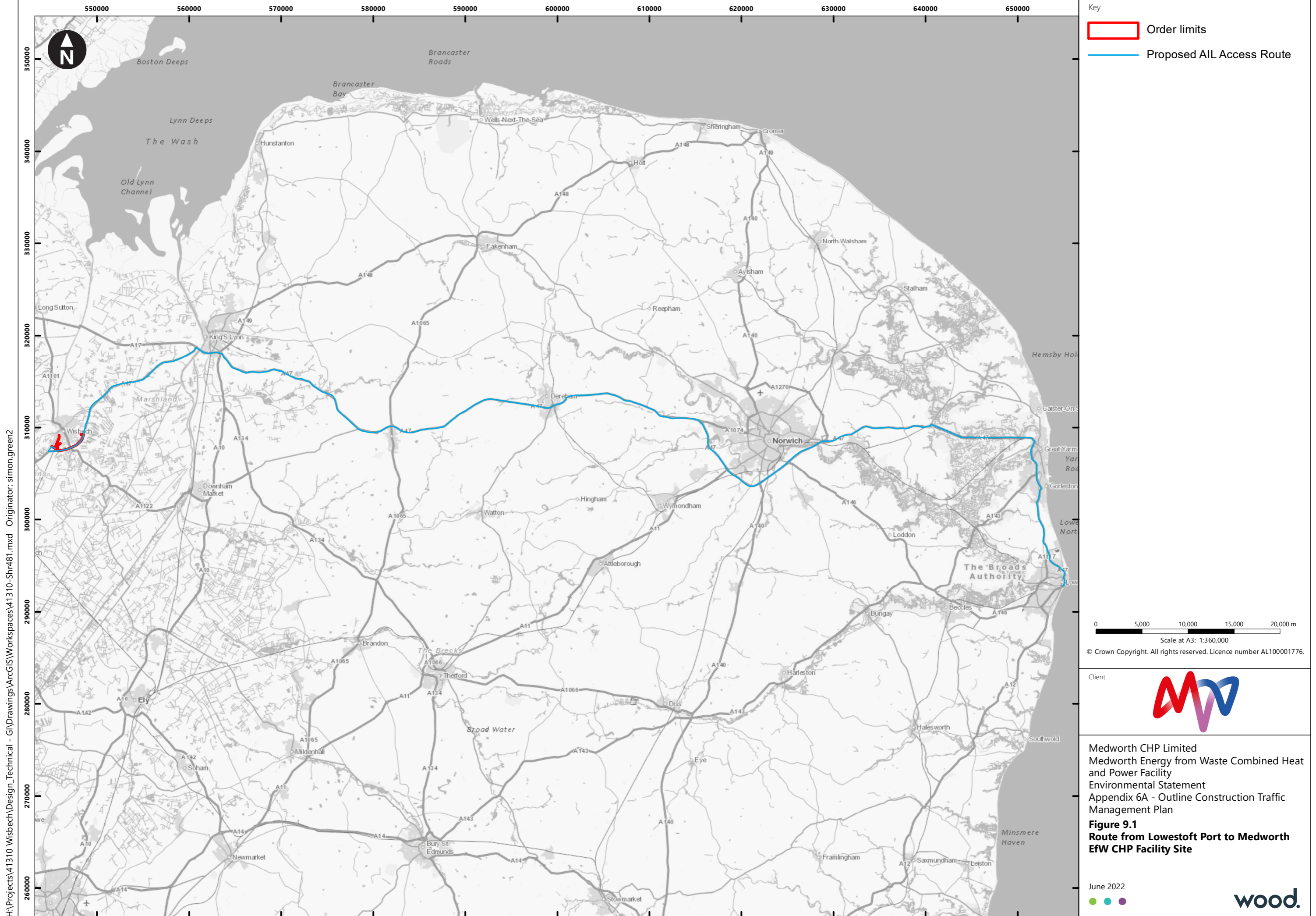

wood.



H:\Projects\41310 Wisbech\Design_Technical - GI\Drawings\ArcGIS\Workspaces\41310-Shr481.mxd Originator: simon.green2

Key
 Order limits
 Proposed AIL Access Route

0 5,000 10,000 15,000 20,000 m
Scale at A3: 1:360,000
© Crown Copyright. All rights reserved. Licence number AL100001776.



Medworth CHP Limited
Medworth Energy from Waste Combined Heat and Power Facility
Environmental Statement
Appendix 6A - Outline Construction Traffic Management Plan
Figure 9.1
Route from Lowestoft Port to Medworth EfW CHP Facility Site

June 2022



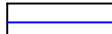
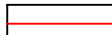
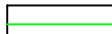
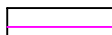

- Key
-  Highway boundary
 -  Vehicle wheel outline
 -  Vehicle body outline
 -  Vehicle load outline

0 m 30 m
 Scale 1:500 @ A3
 © Crown copyright. All rights reserved. Licence number AL100001776.

Medworth CHP Limited
 Medworth Energy from Waste Combined Heat
 and Power Facility DCO
 Environmental Statement
 Appendix 6A - Outline Construction Traffic
 Management Plan
**Figure 9.2 - AIL SPA -
 Cromwell Road / New Bridge Lane**

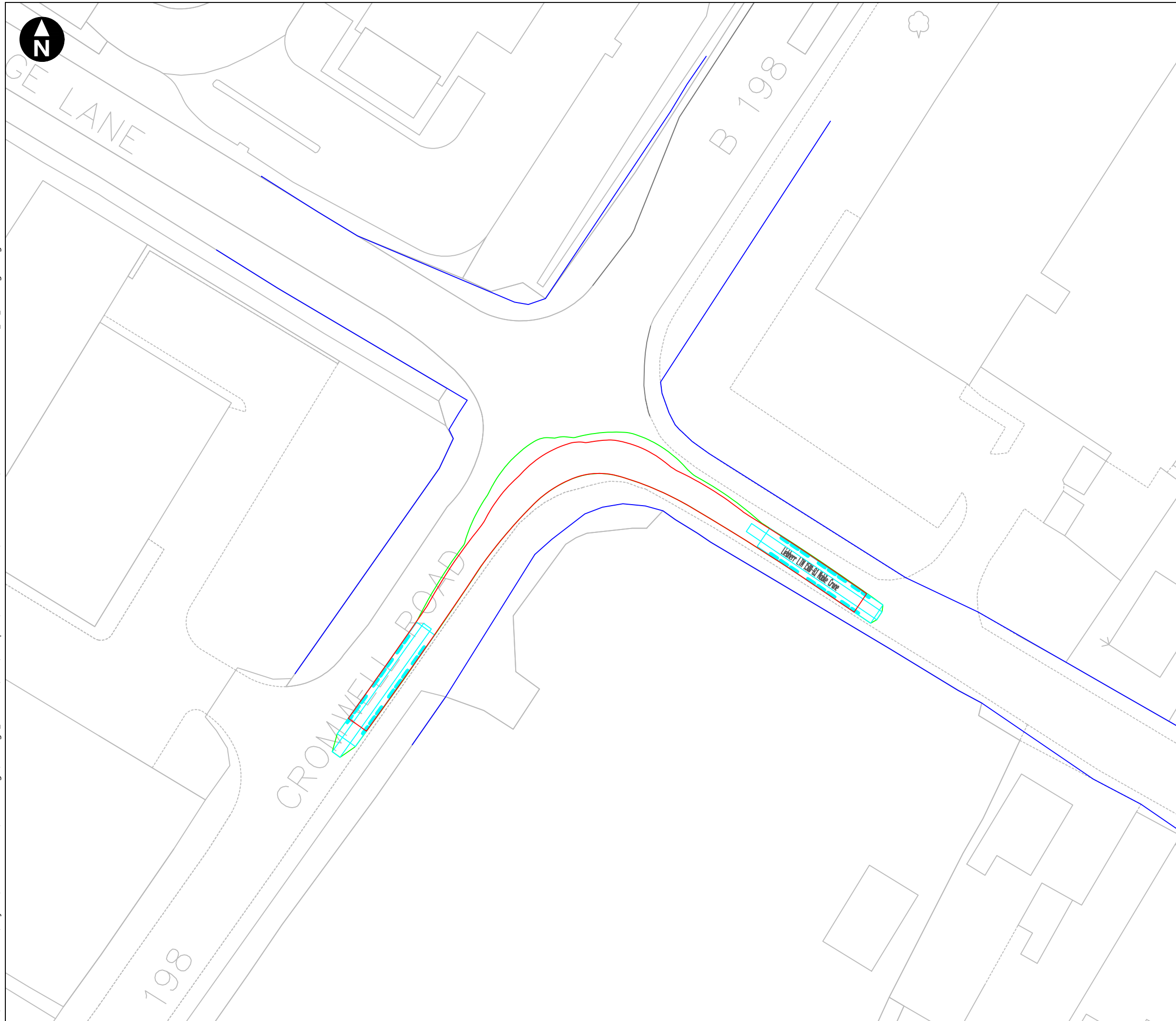

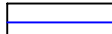
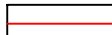
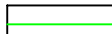
- Key
-  Highway boundary
 -  Vehicle wheel outline
 -  Vehicle body outline

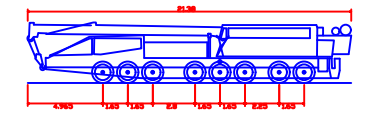

Liebherr LTM 1500-8.1 Mobile Crane	
Overall Length	21.380m
Overall Width	3.000m
Overall Body Height	4.000m
Min Body Ground Clearance	0.350m
Track Width	2.000m
Lock to lock time	4.00s
Kerb to Kerb Turning Radius	13.464m

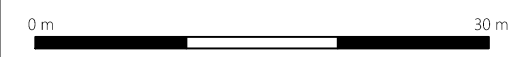

Scale 1:500 @ A3
© Crown copyright. All rights reserved. Licence number AL100001776.

Medworth CHP Limited
Medworth Energy from Waste Combined Heat and Power Facility DCO

Figure 9.2ii AIL SPA - New Bridge Lane/Cromwell Road

April 2023



H:\Projects\41310 Wisbech\Deliver Stage\Design\Technical\Data\Transport\Access schemes\41310-WOOD-XX-XX-DR-OT-0016_S0_P06.dwg Originator: ADAM.GUY

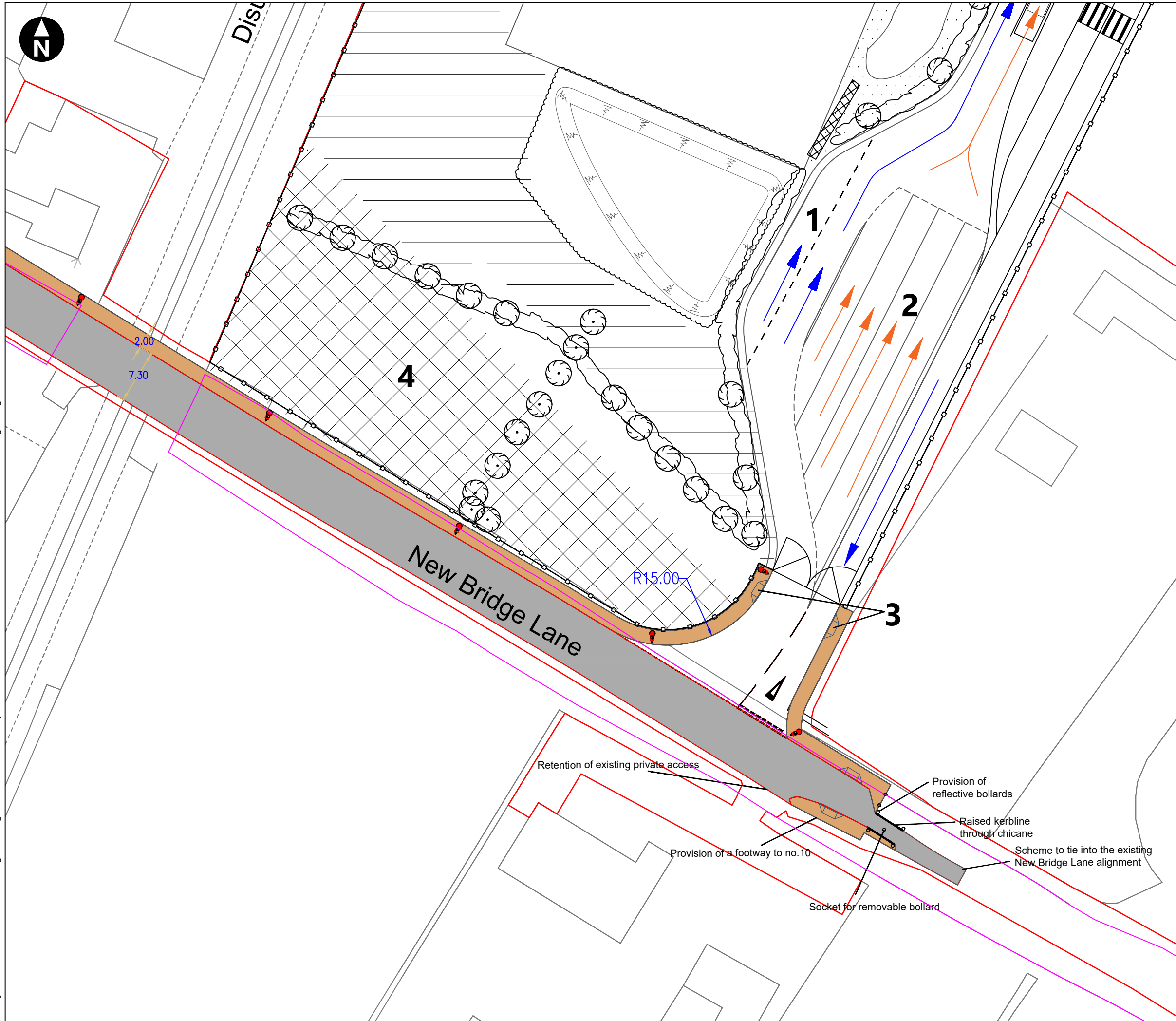

- Key
- Order limits
 - Proposed access scheme
 - Highways boundary
 - Indicative new street lighting
 - Existing street lighting
 - 1** Layby
 - 2** Vehicle queuing area
 - 3** Dropped kerb crossing
 - 4** Rail embankment (by others) reservation area

- Notes:
1. Proposed visibility based on New Bridge Lane being subject to a revised 30mph speed limit.
 2. Visibility requirements 2.4m x 70m, desirable minimum.
 3. New street lighting has been provided on an indicative basis (at 30m intervals and at conflict areas) and will require detailed design and assessment.
 4. Access for No.10 New Bridge Lane through a chicane; subject to the agreement of the Highways Authority. Socket for removable bollard provided and if experienced, a bollard may be installed by the highways authority to prevent through traffic.

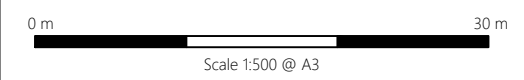

© Crown copyright. All rights reserved. Licence number AL100001776.

Medworth CHP Limited
 Medworth Energy from Waste Combined Heat and Power Facility DCO
 Environmental Statement
 Outline Construction Traffic Management Plan

Figure 10.1i
New Bridge Lane access design

March 2023



H:\Projects\41310 Wisbech\Deliver Stage\Design\Technical\Data\Transport\Access schemes\41310-WOOD-XX-XX-DR-OT-0016_S0_P06.dwg Originator: ADAM.GUY

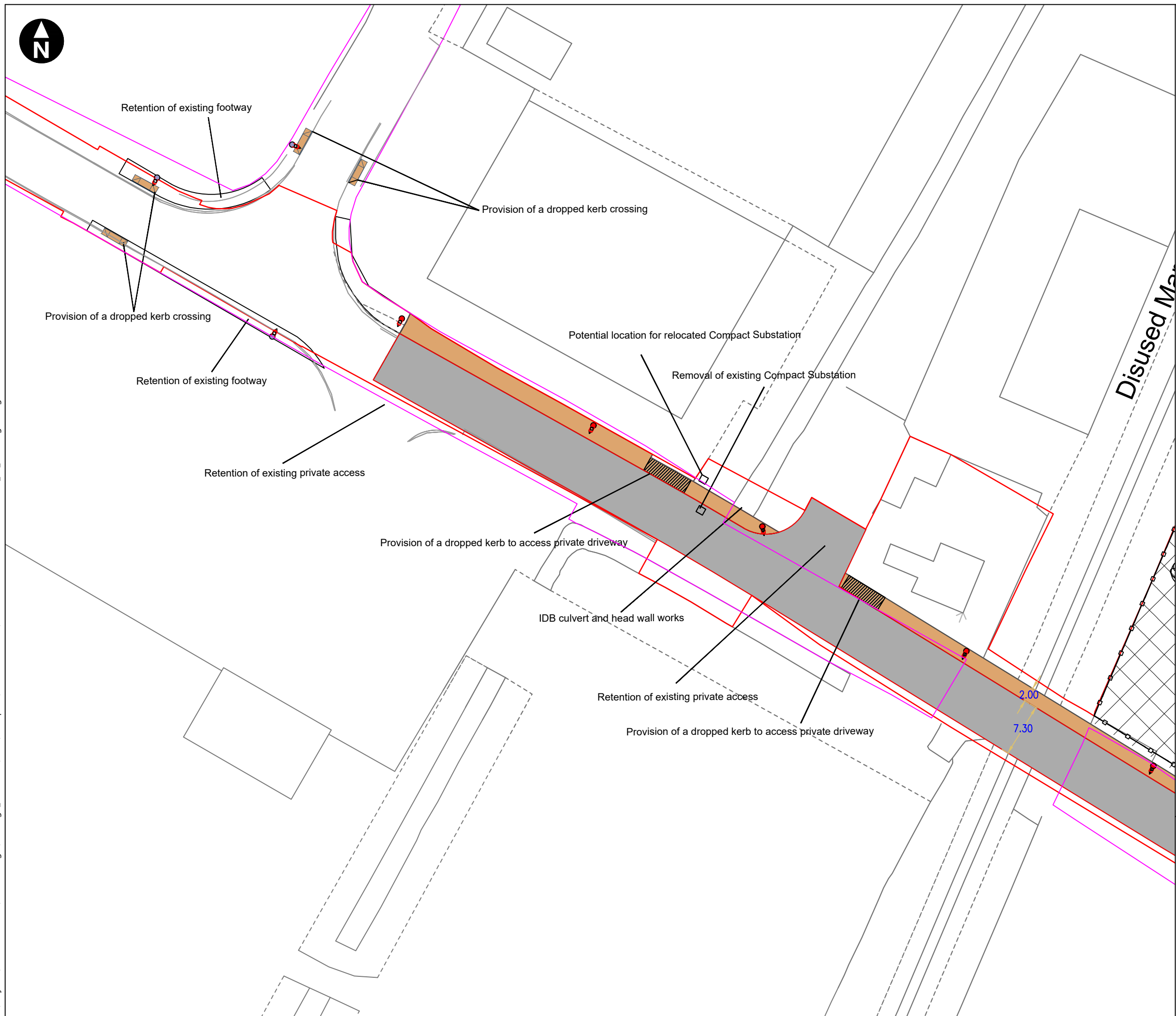

Key

- Order limits
- Proposed access scheme
- Highways boundary
- Indicative new street lighting
- Existing street lighting

- Notes:
1. New street lighting has been provided on an indicative basis (at 30m intervals and at conflict areas) and will require detailed design and assessment.
 2. Compact substation to be relocated within Order limits.
 3. Works to IDB drain either to a) replace culvert/headwall; or b) extend existing culvert and provide new headwall. See Figure 3.18 for general arrangements.



© Crown copyright. All rights reserved. Licence number AL100001776.

Medworth CHP Limited
Medworth Energy from Waste Combined Heat and Power Facility DCO
Environmental Statement
Outline Construction Traffic Management Plan

Figure 10.1ii
New Bridge Lane access design



March 2023

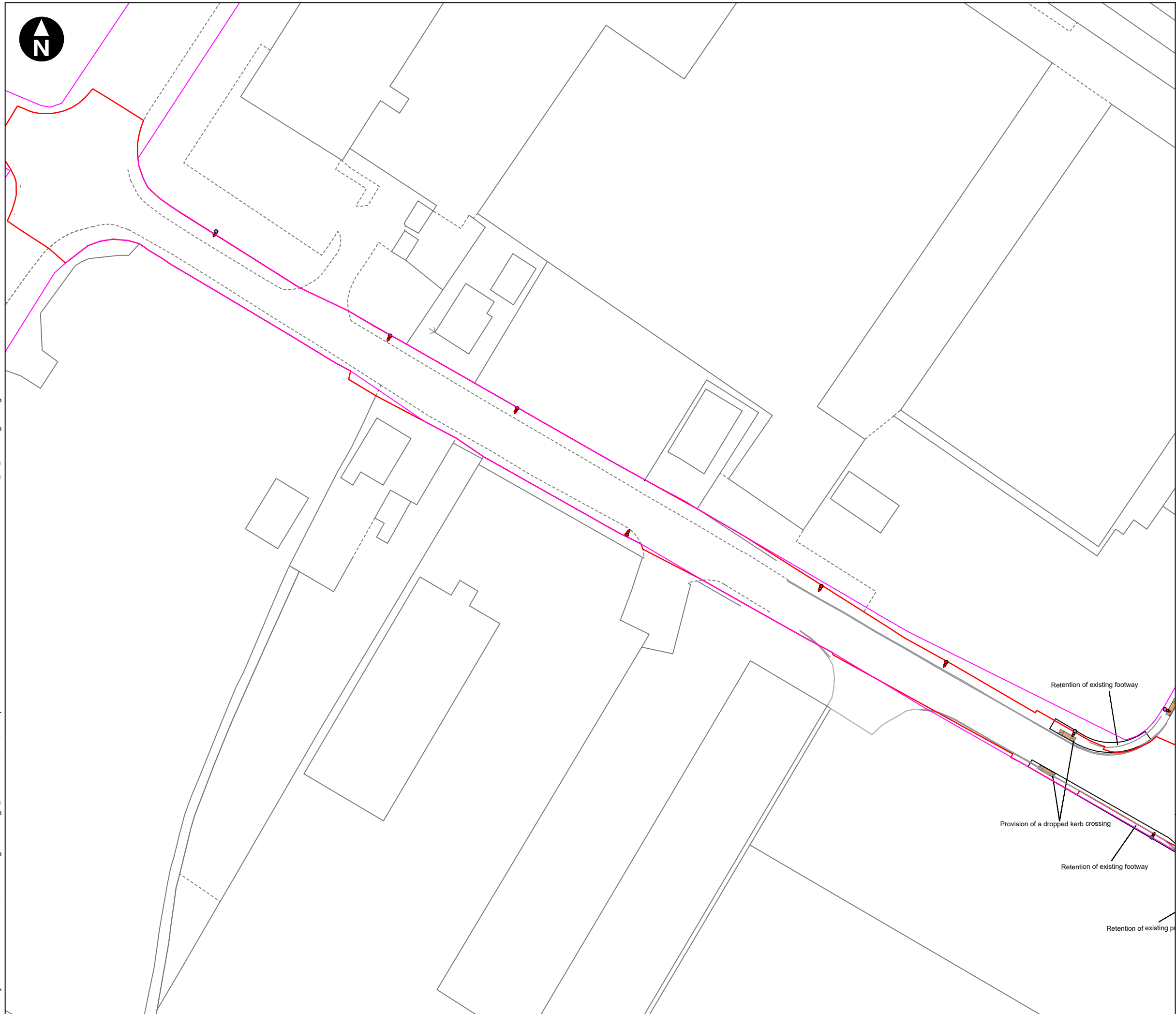

H:\Projects\41310 Wisbech\Deliver Stage\Design_Technical\Data\Transport\Access schemes\41310-WOOD-XX-XX-DR-OT-0016_S0_P06.dwg Originator: ADAM.GUY

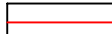
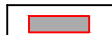
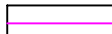

Key

-  Order limits
-  Proposed access scheme
-  Highways boundary
-  Indicative new street lighting
-  Existing street lighting

- Notes:
1. Proposed visibility based on New Bridge Lane being subject to a revised 30mph speed limit.
 2. New street lighting has been provided on an indicative basis (at 30m intervals and at conflict areas) and will require detailed design and assessment.



© Crown copyright. All rights reserved. Licence number AL100001776.

Medworth CHP Limited
 Medworth Energy from Waste Combined Heat and Power Facility DCO
 Environmental Statement
 Outline Construction Traffic Management Plan

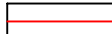
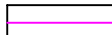

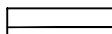

Figure 10.1iii
New Bridge Lane access proposal

March 2023





Key

-  Order limits
-  Highways boundary
-  Primary signal head
-  Secondary signal head
-  Indicative road marking scheme
-  Kerb realignment for HGV movements

- Notes:
1. Newbridge lane Topographical Survey undertaken by MFM Land Surveys and Engineering Services Ltd between 6-9 November 2019.
 2. Outside the extents of the topographical survey this scheme has been developed using OS basemapping.
 3. Road markings are based on guidance within chapters 5 and 6 of the Traffic Signs Manual, 2019.



© Crown copyright. All rights reserved. Licence number AL100001776.

Medworth CHP Limited
 Medworth Energy from Waste Combined Heat and Power Facility DCO
 Environmental Statement
 Outline Construction Traffic Management Plan

Figure 10.1iv
Cromwell Road/New Bridge Lane Signal Scheme - General arrangement

March 2023

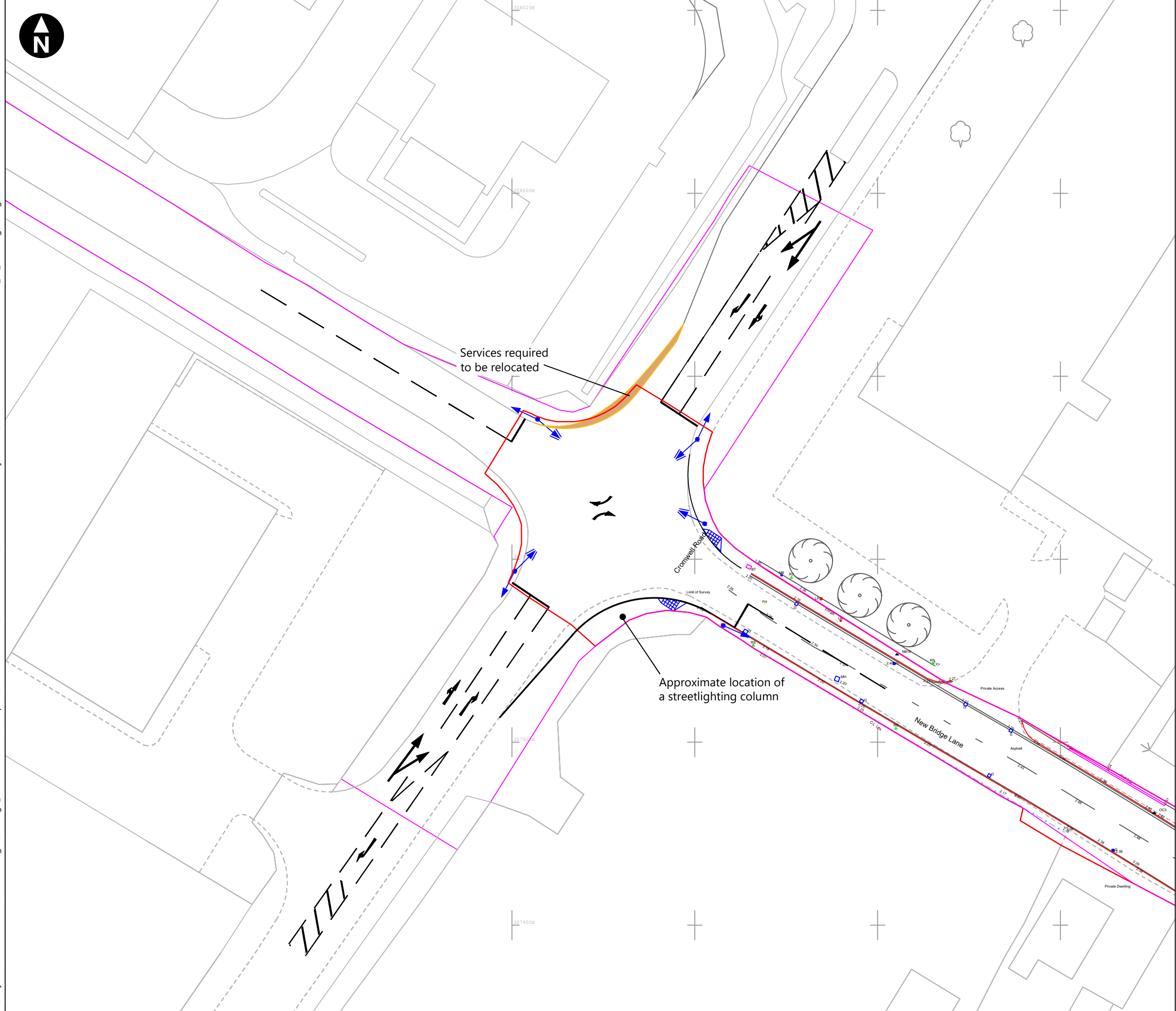

H:\Projects\41310 Wisbech\Deliver Stage\Design\Technical\Data\Transport\Access schemes\Post submission\Newbridge lane\41310-WOOD-XX-XX-DR-OT-0025_S0_P02.dwg Originator: ADAM.GUY

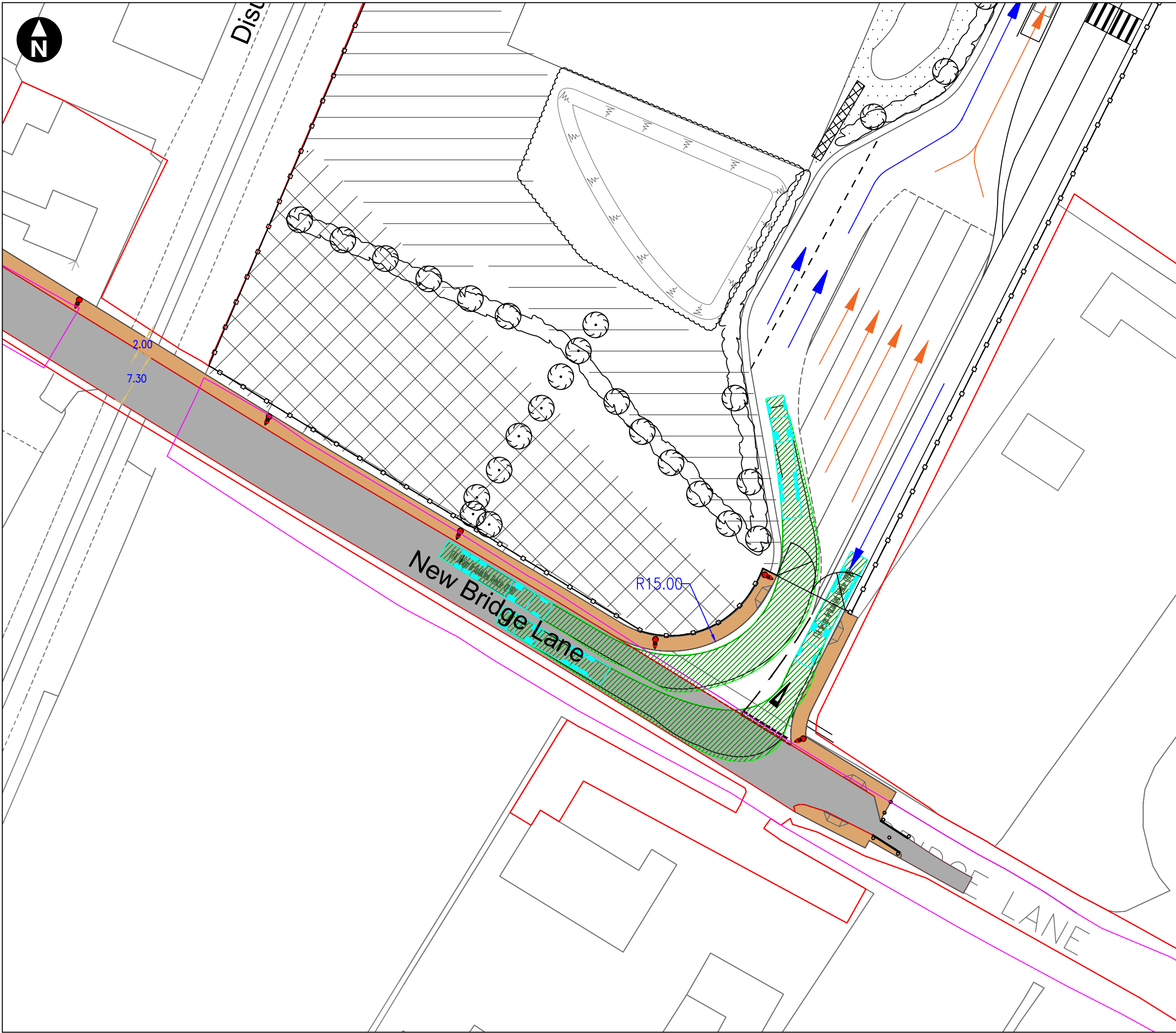

- Key
- Order limits
 - Proposed access scheme
 - Highways boundary
 - Vehicle body outline
 - Vehicle wheel track
 - Vehicle swept path envelope

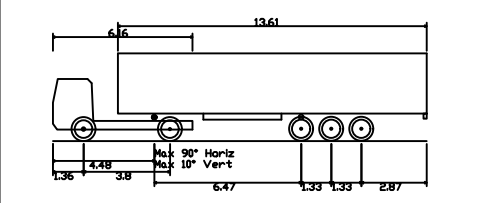

FTA Design Articulated Vehicle (1998)	16.48m
Overall Length	16.48m
Overall Width	2.55m
Overall Body Height	3.87m
Min Body Ground Clearance	0.515m
Max Track Width	2.47m
Lock to lock time	3.00s
Kerb to Kerb Turning Radius	6.550m



© Crown copyright. All rights reserved. Licence number AL100001776.

Medworth CHP Limited
 Medworth Energy from Waste Combined Heat
 and Power Facility DCO
 Environmental Statement
 Outline Construction Traffic Management Plan

Figure 10.1v
Newbridge Lane vehicle tracking -
Operational access HGV swept path

March 2023



H:\Projects\41310 Wisbech\Design\Stage\Design\Technical\Data\Transport\Access schemes\Post submission\Newbridge lane\41310-WOOD-XX-XX-DR-OT-0025_S0_P02.dwg Originator: ADAM.GUY



- Key
- Order limits
 - Proposed access scheme
 - Highways boundary
 - Vehicle body outline
 - Vehicle wheel track
 - Vehicle swept path envelope

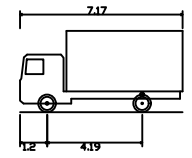

FTA Design LG Rigid Vehicle (1998)	
Overall Length	7.170m
Overall Width	2.300m
Overall Body Height	3.580m
Min. Body Ground Clearance	0.375m
Track Width	2.120m
Lock to lock time	3.00s
Kerb to Kerb Turning Radius	7.000m

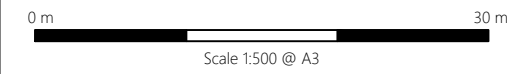

© Crown copyright. All rights reserved. Licence number AL100001776.

Medworth CHP Limited
 Medworth Energy from Waste Combined Heat and Power Facility DCO
 Environmental Statement
 Outline Construction Traffic Management Plan

Figure 10.1vi
Newbridge Lane vehicle tracking - private access LGV swept path

March 2023



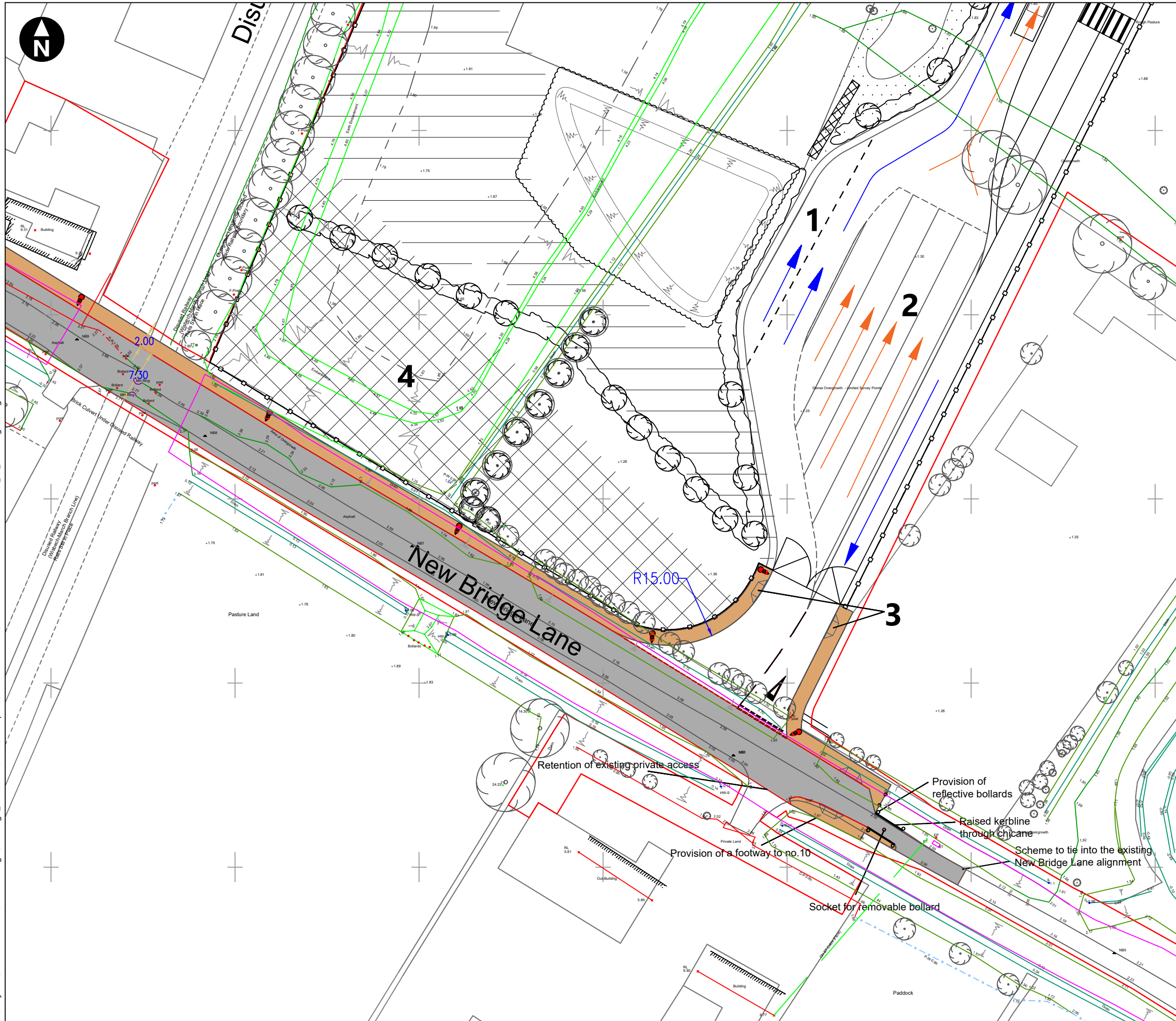

Key

- Order limits
- Proposed access scheme
- Highways boundary
- Indicative new street lighting
- Layby
- Vehicle queuing area
- Dropped kerb crossing
- Rail embankment (by others) reservation area

- Notes:**
1. Proposed visibility based on New Bridge Lane being subject to a revised 30mph speed limit.
 2. Visibility requirements 2.4m x 70m, desirable minimum.
 3. New street lighting has been provided on an indicative basis (at 30m intervals and at conflict areas) and will require detailed design and assessment.
 4. Access for No.10 New Bridge Lane through a chicane; subject to the agreement of the Highways Authority. Socket for removable bollard provided and if experienced, a bollard may be installed by the highways authority to prevent through traffic.
 5. Topographical Survey undertaken by MFM Land Surveys and Engineering Services Ltd between 6-9 November 2019.

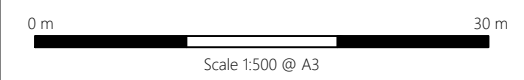

© Crown copyright. All rights reserved. Licence number AL100001776.

Medworth CHP Limited
 Medworth Energy from Waste Combined Heat and Power Facility DCO
 Environmental Statement
 Outline Construction Traffic Management Plan

Figure 10.1vii
New Bridge Lane access proposal with Topographical Survey

March 2023



H:\Projects\41310 Wisbech\Technical\Design\Stage\Deliver Stage\Design\Access schemes\41310-WOOD-XX-XX-DR-OT-0026_S0_P02.dwg Originator: ADAM.GUY

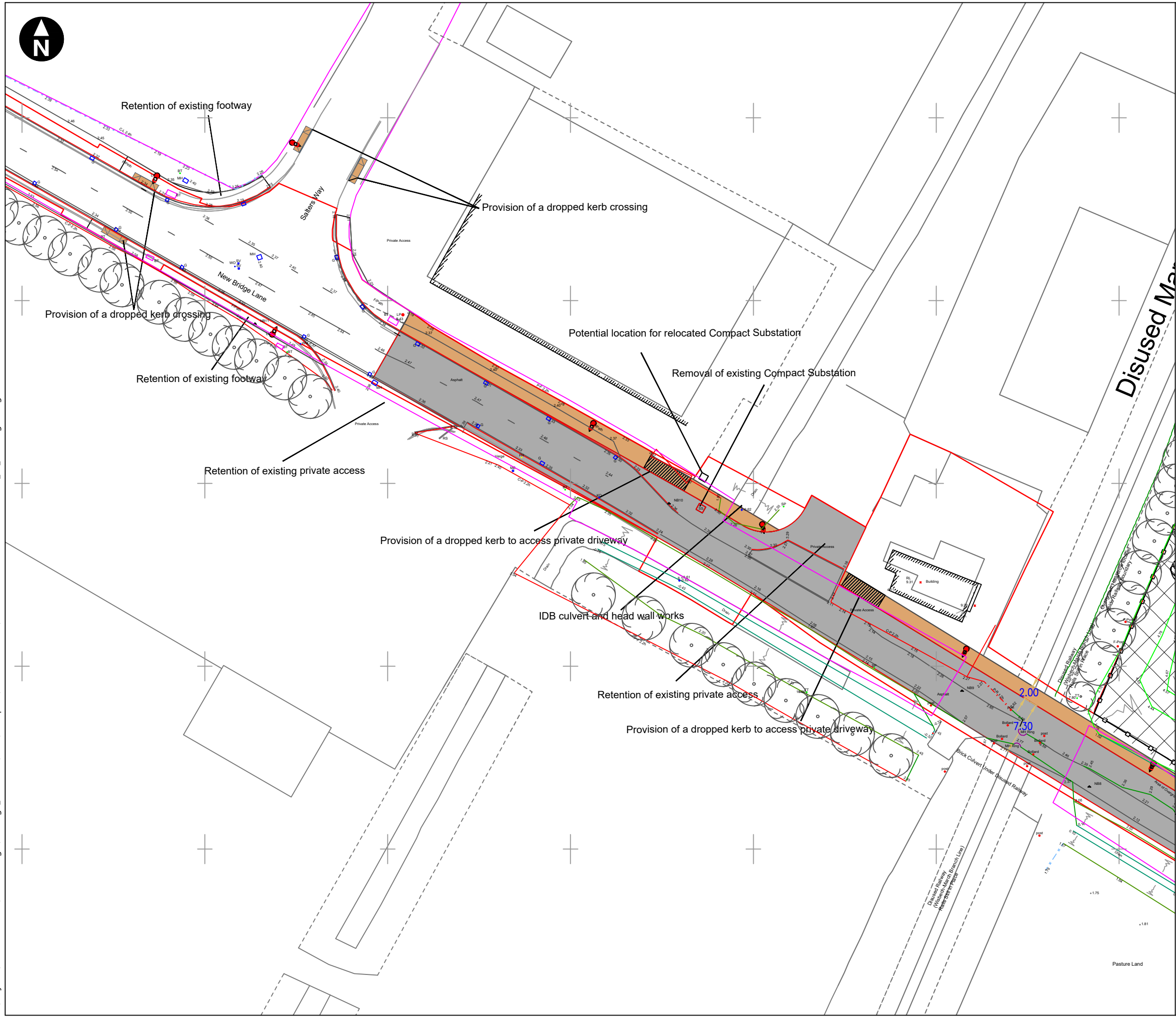

Key

- Order limits
- Proposed access scheme
- Highways boundary
- Indicative new street lighting

- Notes:
1. New street lighting has been provided on an indicative basis (at 30m intervals and at conflict areas) and will require detailed design and assessment.
 2. Compact substation to be relocated within Order limits.
 3. Works to IDB drain either to a) replace culvert/headwall; or b) extend existing culvert and provide new headwall.
 4. Topographical Survey undertaken by MFM Land Surveys and Engineering Services Ltd between 6-9 November 2019.

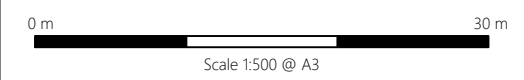

© Crown copyright. All rights reserved. Licence number AL100001776.

Medworth CHP Limited
Medworth Energy from Waste Combined Heat and Power Facility DCO
Environmental Statement
Outline Construction Traffic Management Plan

Figure 10.1viii
New Bridge Lane access proposal with Topographical Survey

March 2023



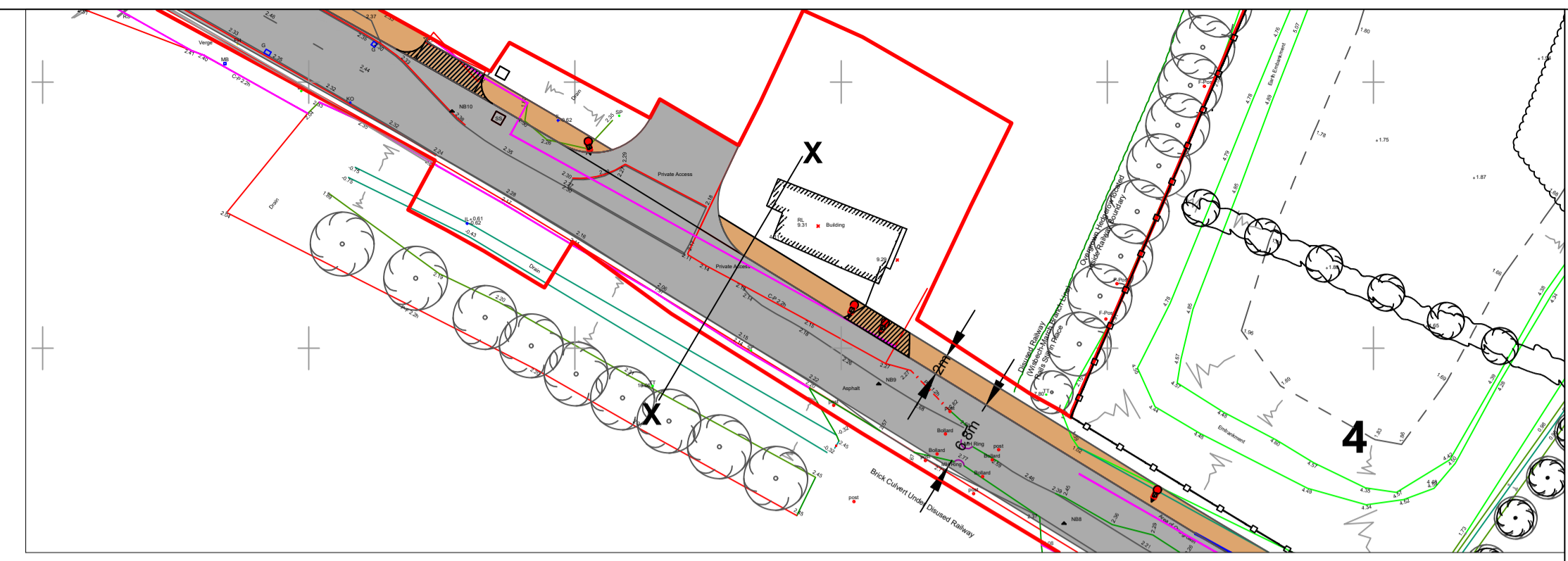

- Key**
1. Carriageway widths based on guidance within Cambridgeshire Highways Development Management, General Principles for Development guidance, January 2023.
 2. Carriageway and footway construction details based on guidance within Cambridgeshire County Council Housing Estate Road Construction Specification, January 2023.
 3. Kerb details based on guidance within Cambridgeshire County Council Housing Estate Road Construction Specification January 2023 and manufacturers guidance for the installation of trief kerbs.
 4. Final highways construction, sheet piling arrangements and drainage details to be developed during detailed design stage.

Cross section through x-x

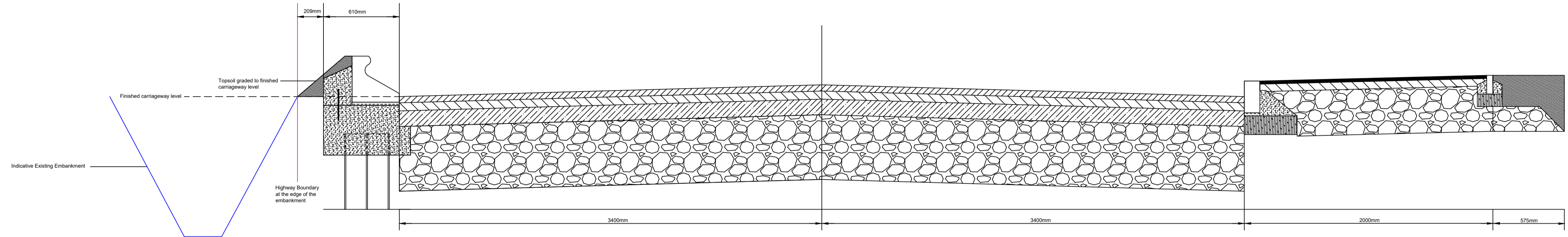

Carriageway construction details

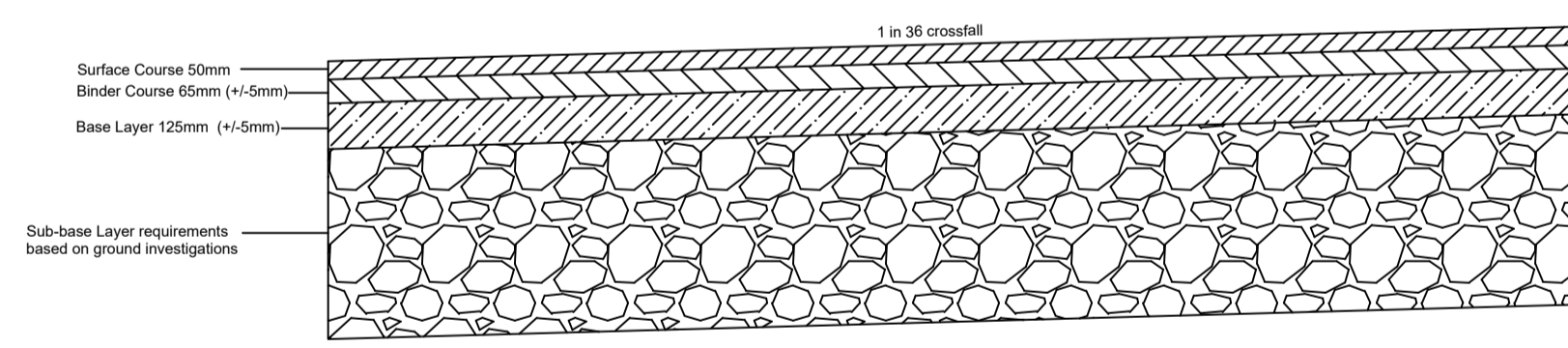

Notes:
The following requirements are set out in Housing Estate Road (HER) Construction Specification January 2023, Cambridgeshire County Council:

- Unless in-situ testing has been agreed by the engineer the CBR for the site will be assumed < 2%. Sub-base may be reduced in line with the following if suitable test results are provided.

Measured CBR values	Required depth of type 1 or HER sub-base
CBR >5%	260mm +/-10mm
CBR 5%	280mm +/-10mm
CBR 4%	315mm +/-10mm
CBR 3%	375mm +/-10mm
CBR 2%	450mm +/-10mm
CBR <2%	520mm +/-10mm

Footway construction details

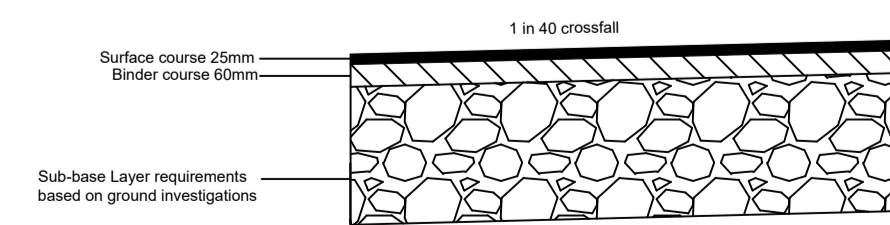

Carriageway southern edge with trief kerb and sheet piling

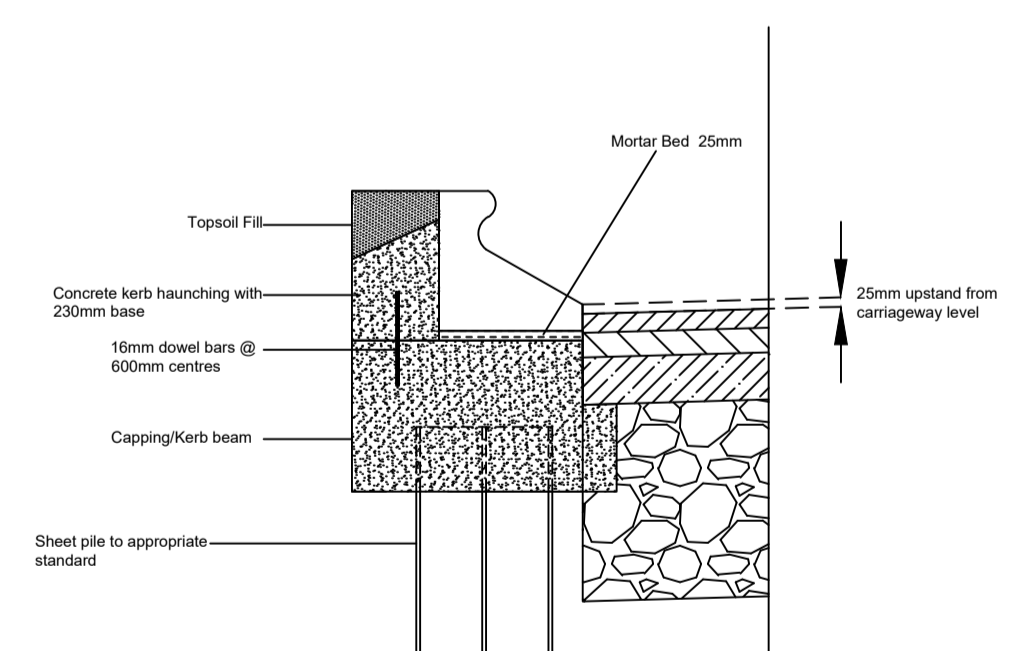

Carriageway northern edge with kerbing and footway

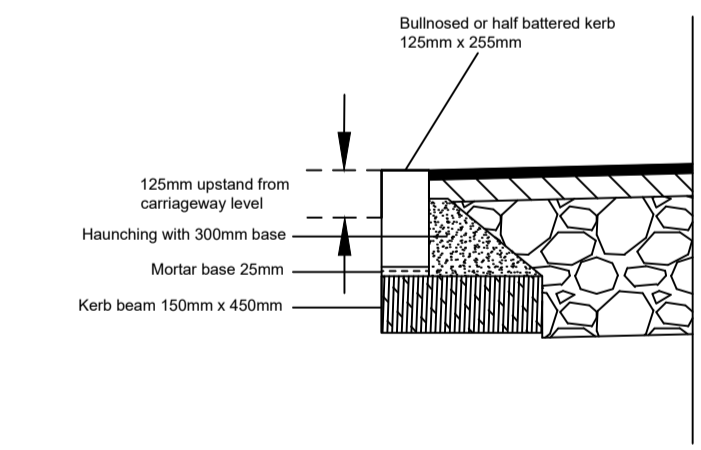

Footway northern edge with kerbing and granular material layout

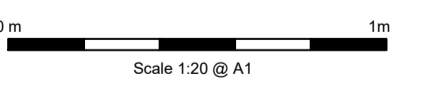
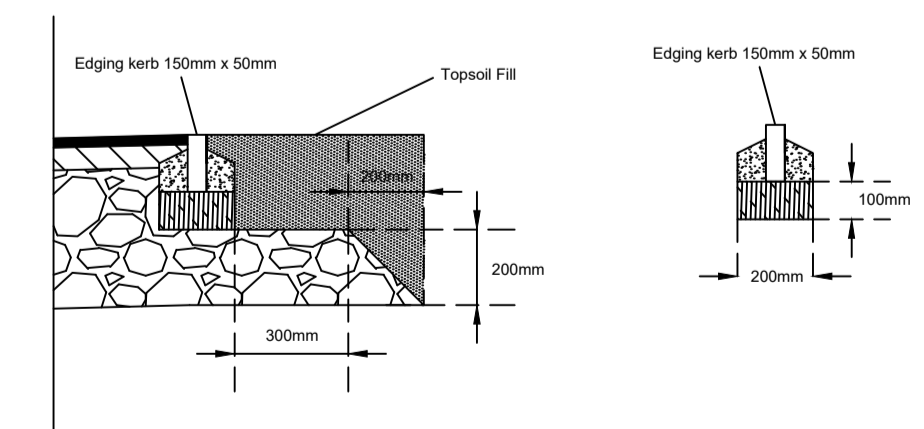

© Crown copyright. All rights reserved. Licence number AL100001776.

Medworth CHP Limited
Medworth Energy from Waste Combined Heat and Power Facility DCO



New Bridge Lane Cross Section and outline highway construction details

H:\SAL\FS\2-SHARED\Projects\41310\Woods\XX-XX-DR-OT-0033_S0_P01.3.dwg Originator: ADAM.GUY

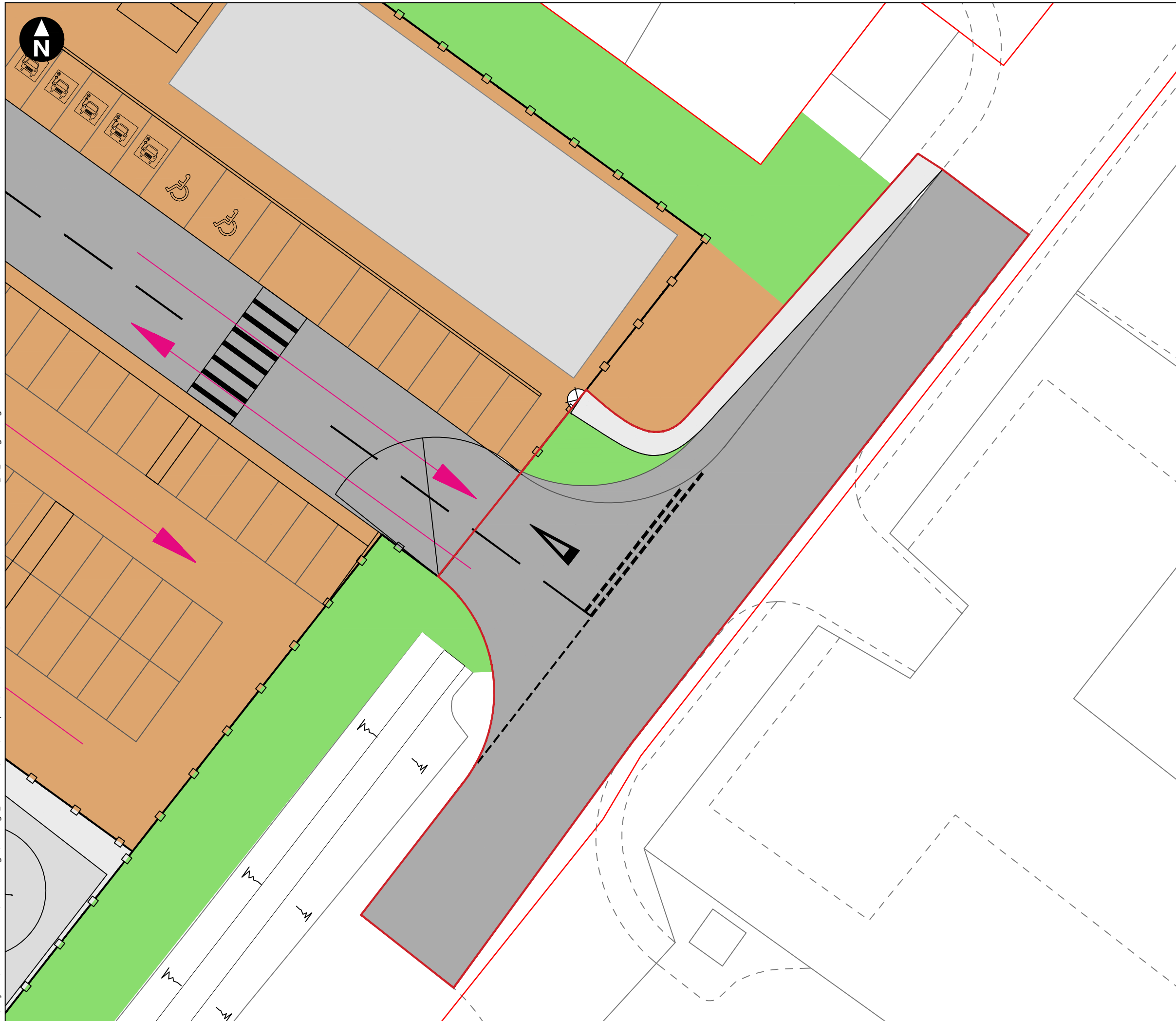
H:\Projects\41310 Wisbech\Deliver Stage\Design\Technical\Data\Transport\Access schemes\41310-WOOD-XX-XX-DR-OT-0020_S0_2.dwg Originator: ADAM.GUY



Key

-  Proposed access scheme
-  Proposed road markings

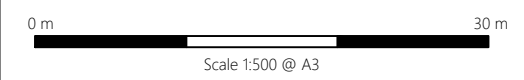

© Crown copyright. All rights reserved. Licence number AL100001776.

Medworth CHP Limited
 Medworth Energy from Waste Combined Heat
 and Power Facility DCO
 Environmental Statement
 Outline Construction Traffic Management Plan

Figure 10.2
Algores Way operational access design

March 2023



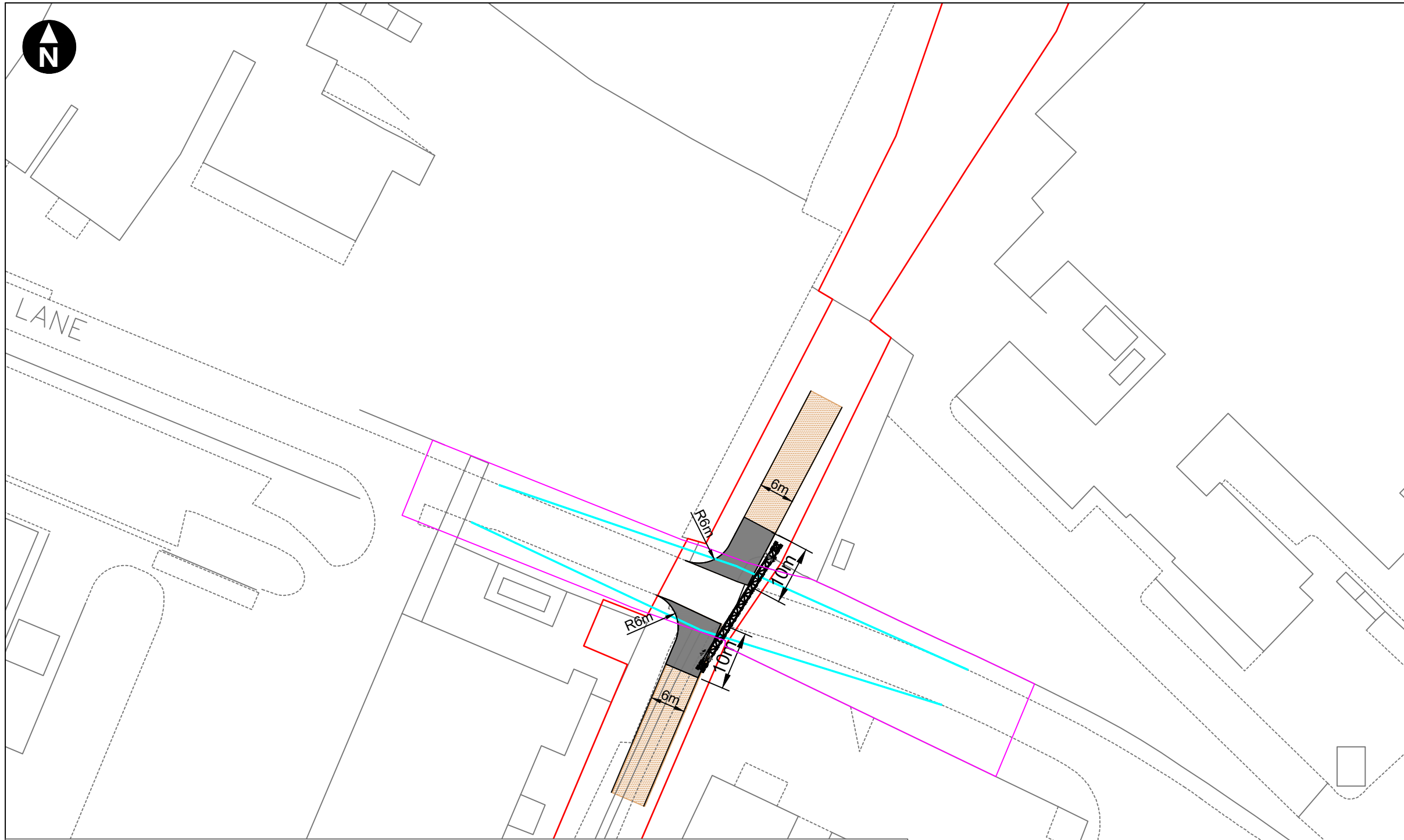

- Key
- Existing
 - Kerb
 - Order limits
 - Sealed surface
 - Temporary surface
 - Visibility splay (2.4m x 43m)
 - Highway boundary

Note:
Installation of the pipe bridge to be post construction works involving HGV deliveries along the CHP corridor off Weasenham Lane.

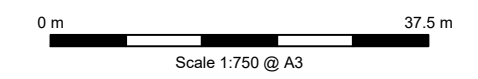

© Crown copyright. All rights reserved. Licence number AL100001776.



Medworth CHP Limited
Medworth Energy from Waste Combined Heat and Power Facility DCO

Figure 10.3i Proposed Construction Access Weasenham Lane

June 2023

